

# Acer

## Aspire 9300/7000 TravelMate 7510 Service Guide

Service guide files and updates are available on the ACER/CSD web. For more information, please refer to <http://csd.acer.com.tw>

---

## Revision History

Please refer to the table below for the updates of Aspire 9300 / 7000 & TravelMate 7510 service guide.

Date	Chapter	Updates

---

## **Copyright**

Copyright© 2006 by Acer Incorporated. All rights reserved. No part of this publication may be reproduced, transmitted, transcribed, stored in a retrieval system, or translated into any language or computer language, in any form or by any means, electronic, mechanical, magnetic, optical, chemical, manual or otherwise, without the prior written permission of Acer Incorporated.

---

## **Disclaimer**

The information in this guide is subject to change without notice.

Acer Incorporated makes no representations or warranties, either expressed or implied, with respect to the contents hereof and specifically disclaims any warranties of merchantability or fitness for any particular purpose. Any Acer Incorporated software described in this manual is sold or licensed "as is". Should the programs prove defective following their purchase, the buyer (and not Acer Incorporated, its distributor, or its dealer) assumes the entire cost of all necessary servicing, repair, and any incidental or consequential damages resulting from any defect in the software.

Acer is a registered trademark of Acer Incorporated.

Intel is a registered trademark of Intel Corporation.

Pentium and Pentium D are trademarks of Intel Corporation.

Other brand and product names are trademarks and/or registered trademarks of their respective holders.



---

## Conventions

The following conventions are used in this manual:

SCREEN MESSAGES	Denotes actual messages that appear on screen.
NOTE	Gives bits and pieces of additional information related to the current topic.
WARNING	Alerts you to any damage that might result from doing or not doing specific actions.
CAUTION	Gives precautionary measures to avoid possible hardware or software problems.
IMPORTANT	Reminds you to do specific actions relevant to the accomplishment of procedures.

---

## Preface

Before using this information and the product it supports, please read the following general information.

1. This Service Guide provides you with all technical information relating to the BASIC CONFIGURATION decided for Acer's "global" product offering. To better fit local market requirements and enhance product competitiveness, your regional office MAY have decided to extend the functionality of a machine (e.g. add-on card, modem, or extra memory capability). These LOCALIZED FEATURES will NOT be covered in this generic service guide. In such cases, please contact your regional offices or the responsible personnel/channel to provide you with further technical details.
2. Please note WHEN ORDERING FRU PARTS, you should check the most up-to-date information available on your regional web or channel. For whatever reason, if a part number change is made, it will not be noted in the printed Service Guide. For ACER-AUTHORIZED SERVICE PROVIDERS, your Acer office may have a DIFFERENT part number code to those given in the FRU list of this printed Service Guide. You MUST use the list provided by your regional Acer office to order FRU parts for repair and service of customer machines.

---

## Chapter1 System Specification 1

Features	1
Platform	1
System Memory	1
Display	1
Graphics	1
Storage Subsystem	2
Optical media drive	2
Communication	2
I/O Interface	2
Power Subsystem	3
Dimensions and Weight	3
Environment	3
Block Diagram	4
Outlook Tour	5
Front View	5
Closed Front View	6
Left View	7
Right View	7
Rear View	8
Base View	8
Using the Keyboard	10
Lock keys and Embedded Numeric Keypad	10
Windows keys	11
Hotkeys	11
Special keys	12
Indicators	14
Easy-launch Buttons	15
Touchpad	16
Touchpad Basics	16
Acer Empowering Technology	18
Acer eDataSecurity Management	19
Acer eLock Management	21
Acer ePerformance Management	22
Acer eRecovery Management	23
Acer eSettings Management	24
Acer eNet Management	25
Acer ePower Management	27
Acer ePresentation Management	29
Acer OrbiCam	30
Using the System Utilities	36
Acer GridVista (dual-display compatible)	36
Launch Manager	37
Norton AntiVirus	38
How do I check for viruses	38
Hardware Specification and Configuration	39

## Chapter2 System Utilities 48

BIOS Setup Utility	48
Information	49
Main	50

---

Security	52
Set Supervisor/User Password	53
Characters	0-9,A-Z (not case sensitive) 53
Boot	55
Exit	56

## **Chapter3 Machine Disassembly and Replacement 57**

General Information	57
Before You Begin	57
Disassembly Procedure Flowchart	58
Disassembly Procedure	60
Removing the Battery Pack	60
Removing the HDD Module	60
Removing the Wireless LAN Card and the RAM Modules	61
Removing the Keyboard	63
Separating the LCD Module and Main Unit	64
Disassembling the Main Unit	65
LCD Disassembly	72

## **Chapter4 Troubleshooting 76**

System Check Procedures	77
External Diskette Drive Check	77
External CD-ROM Drive Check	77
Keyboard or Auxiliary Input Device Check	77
Memory Check	78
Power System Check	78
Check the Power Adaptor	78
Check the Battery Pack	79
Touchpad Check	79
Power-On Self-Test (POST) Error Message	81
Index of Error Messages	82
Error Message List	82
Phoenix BIOS Beep Codes	83
Index of Symptom-to-FRU Error Message	88
Intermittent Problems	92
Undetermined Problems	93
Top View	94

## **Chapter5 Jumper and Connector Location 94**

Bottom View	96
Switch Setting	97
Password Bypassing & BIOS Recovery	98

## **Chapter6 FRU (Field Replaceable Unit) List 100**

Exploded Diagram	101
Parts	102

## **Appendix A Model Definition and Configuration 114**

---

## **Appendix B Test Compatible Components 124**

Microsoft® Windows® XP Pro Environment Test 125

## **Appendix C Online Support Information 129**

# System Specification

---

## Features

### Platform

#### Aspire 9300 Series

- ❑ AMD™ Turion 64 X2 Mobile Technology TL-52/TL-56/TL-60 (1.6/1.8/2GHz, 2 x 512 KB L2 cache), TL-50 (1.6GHz, 2 x 256 KB L2 cache) featuring:
- ❑ Dual-core processing
- ❑ Simultaneous 32 bit and 64 bit Windows® support
- ❑ AMD PowerNow!™, AMD HyperTransport™, Enhanced Virus Protection2 and 3DNow! professional technology

#### Aspire 7000 Series

- ❑ AMD Sempron™ Mobile Technology 3200+/3500+(1.6/1.8 GHz, 512 KB L2 cache), 3400+ (1.8 GHz, 256 KB L2 cache), or higher, featuring:
- ❑ Simultaneous 32 bit and 64 bit Windows® support
- ❑ AMD PowerNow!™, AMD HyperTransport™, Enhanced Virus Protection2 and 3DNow! professional technology

### System Memory

- ❑ Up to 2GB of DDR2 533/667MHz memory, upgradeable to 4GB using two soDIMM modules (dual-channel support)

### Display

- ❑ 17.1" WXGA + 200-nit Acer CrystalBrite™ colour TFT LCD (Aspire 9410 / 7110 series) or high brightness TFT LCD (TravelMate 5610 / 5110 series), 1440 x 900 pixel resolution, supporting simultaneous multi-window viewing via Acer GridVista™

### Graphics

- ❑ NVIDIA® GeForce® Go 7300 up to 512MB TurboCache™ (256MB of dedicated GDDR2 VRAM, 256MB of shared system memory), supporting Microsoft DirectX 9.0, Shader Model3.0, OpenEXR High Dynamic Range (HDR) technology, NVIDIA PowerMizer 6.0, PCI Express®
- ❑ NVIDIA® GeForce® Go 7600 up to 128MB of dedicated GDDR2 VRAM, supporting Microsoft DirectX 9.0, Shader Model3.0, OpenEXR High Dynamic Range (HDR) technology, NVIDIA PowerMizer 6.0, PCI Express®
- ❑ NVIDIA® GeForce® Go 6100 integrated graphics with 64 MB of shared system memory

- 
- ❑ Dual independent displays support
  - ❑ 16.7 million colors
  - ❑ MPEG-2/DVD hardware-assisted capability
  - ❑ Acer Arcade™ featuring Acer CinemaVision™ and Acer ClearVision™ technologies

**NOTE:** TurboCache™ memory allocation varies depending on configuration.

### ***Storage Subsystem***

- ❑ 60/80/100/120/160 GB or higher hard disk drive
- ❑ 5-in-1 card reader, supporting Secure Digital (SD), MultiMediaCard (MMC), Memory Stick® (MS), Memory Stick PRO™ (MS PRO), xD-Picture Card™ (xD)

### ***Optical media drive***

- ❑ 8X DVD-Super Multi double-layer drive
- ❑ 24X DVD/CD-RW combo drive

### ***Communication***

- ❑ Acer Video Conference featuring Voice and Video over internet Protocol (VVoIP) support via Acer OrbiCam™ and optional Acer Bluetooth® VoIP phone
- ❑ Acer OrbiCam™ integrated 1.3 megapixel or 310,000 pixel CMOS camera, featuring:
  - ❑ 225 degree ergonomic rotation
  - ❑ Acer PrimaLite™ technology
- ❑ Modem: 56K ITU V.92 with PTT approval; Wake-on-Ring ready
- ❑ LAN: gigabit Ethernet; Wake-on-LAN ready
- ❑ WPAN: Bluetooth® 2.0 + EDR (Enhanced Data Rate)
- ❑ WLAN: Intel® InviLink™ 802.11b/g Wi-Fi CERTIFIED™ solution, supporting Acer SignalUp™ wireless technology

### ***I/O Interface***

- ❑ PC Card slot (one Type II)
- ❑ 5-in-1 card reader (SD/MMC/MS/MS PRO/xD)
- ❑ Four USB 2.0 ports
- ❑ External display (VGA) port
- ❑ S-video/TV-out (NTSC/PAL) port
- ❑ Headphones/speaker/line-out jack with S/PDIF support
- ❑ Microphone-in jack
- ❑ Line-in jack
- ❑ Ethernet (RJ-45) port
- ❑ Modem (RJ-11) port
- ❑ DC-in jack for AC adapter

---

## ***Power Subsystem***

- ❑ ACPI 2.0 CPU power management standards: Stand-by and Hibernation power-saving modes support
- ❑ 71W 4800mAh (8-cell) or 44W 4000mAh (6-cell) Li-Ion battery pack
- ❑ Acer QuicCharge™ technology: 80% charge in 1 hour; 2-hour rapid charge system-off; 2.5-hour charge-in-use
- ❑ 3-pin 90W AC adapter

## ***Dimensions and Weight***

- ❑ 400 (W) x 295 (D) x 31.4/39.9 (H) mm (15.75 x 11.61 x 1.24/1.57 inches)
- ❑ 3.81 kg (8.39 lbs.) with 8-cell battery pack
- ❑ 3.68 kg (8.10 lbs.) with 6-cell battery pack

## ***Environment***

- ❑ Temperature
  - ❑ Operating: 5 °C to 35 °C
  - ❑ Non-operating: -20 °C to 65 °C
- ❑ Humidity (non-condensing)
  - ❑ Operating: 20% to 80%
  - ❑ Non-operating: 20% to 80%



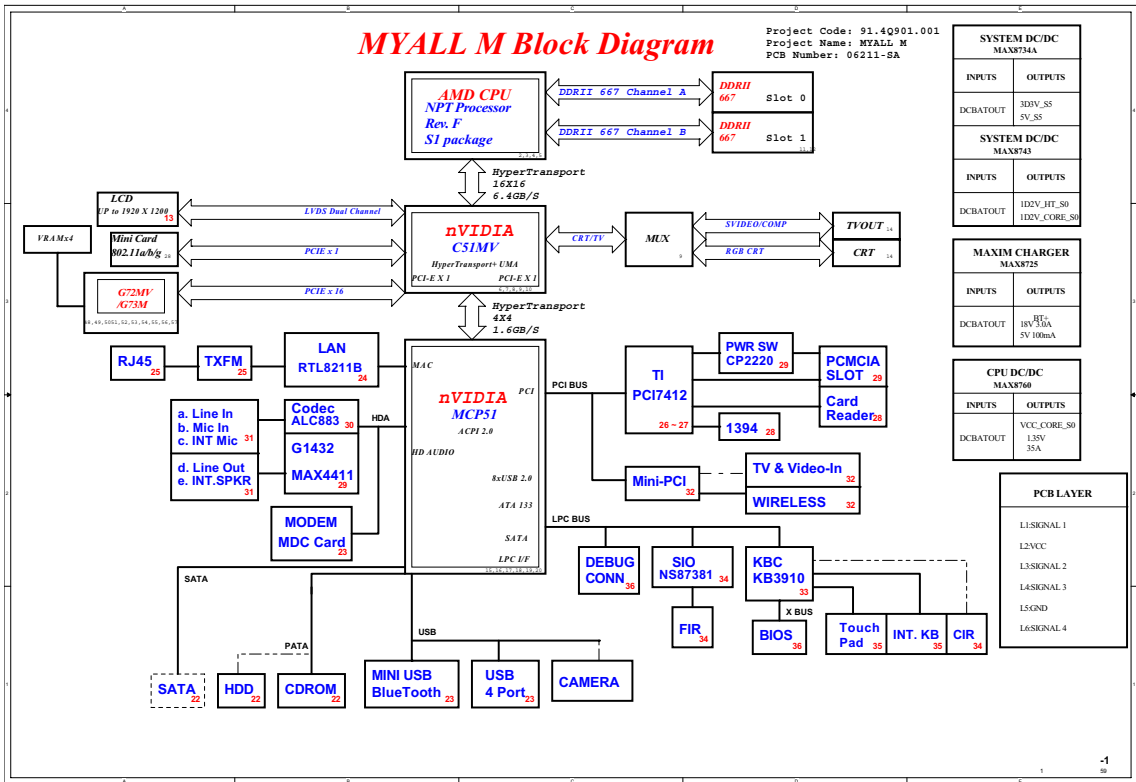

# Block Diagram

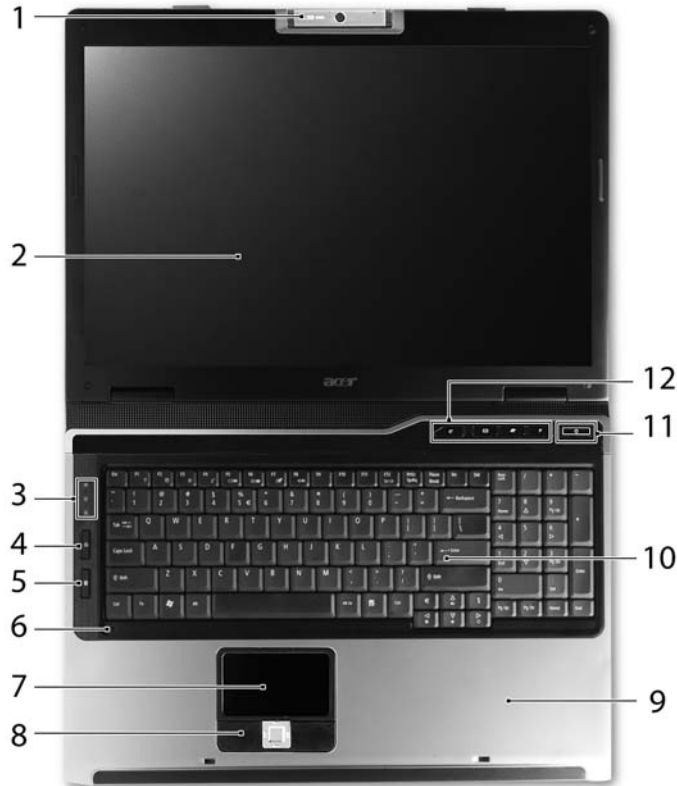

# Outlook Tour

## Front View







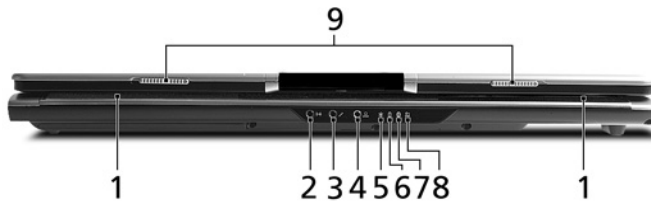

#	Icon	Item	Description
1	N/A	Built-in camera	1.3 megapixel or 310,000 pixel web camera for video communication (for selected models)
2	N/A	Display screen	Also called Liquid-Crystal Display (LCD), displays computer output.
3	N/A	Status indicators	Light-Emitting Diodes (LEDs) that light up to show the status of the computer's functions and components.
4		Wireless communication button	Enable/disables Wireless function. Indicates the status of wireless LAN communications.
5		Bluetooth communication button	Enable/disables Bluetooth function. Indicates the status of Bluetooth communications.
6	N/A	Microphone	Internal microphone for sound recording
7	N/A	Touchpad	Touch-sensitive pointing device which functions like a computer mouse
8	N/A	Click buttons (left, center and right)	The left and right buttons function like the left and right mouse buttons; the center button serves as a four-way scroll button.
9	N/A	Palmrest	Comfortable support area for your hands when you use the computer.

10	N/A	Keyboard	Serves for entering data into your computer.
11	N/A	Power button	Turns the computer on and off.
12	N/A	Easy-launch buttons	Buttons for launching frequently used programs.

## Closed Front View



#	Icon	Item	Description
1	N/A	Speakers	Left and right speakers deliver stereo audio output.
2		Line-in jack	Accepts audio line-in devices (e.g., audio CD player, stereo walkman).
3		Microphone-in jack	Accepts input from external microphones.
4		Headphones/speaker/line-out jack with S/PDIF support	Connects to audio line-out devices (e.g., speakers, headphones).
5		Power indicator	Indicates the computer's power status.
6		Battery indicator	Indicates the computer's battery status.
7		Bluetooth communication indicator	Indicates the status of Bluetooth communication.
8		Wireless communication indicator	Indicates the status of wireless LAN communication.
9	N/A	Latch	Locks and releases the lid.





## Left View

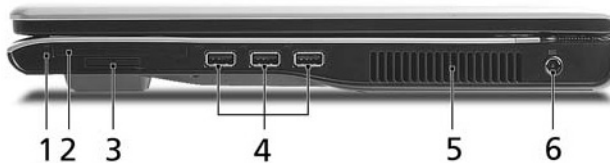

#	Icon	Item	Description
1		Kensington lock slot	Connects to a Kensington-compatible computers security lock.
2	N/A	Optical disk drive	Internal optical drive; accepts CDs or DVDs (slot-load or tray-load depending on model).
3	N/A	Optical disk access indicator	Lights up when the optical disk drive is active.
4	N/A	Optical disk drive eject button	Ejects the drive tray from the drive (location depends on model).
5	N/A	Emergency eject hole	Ejects the drive tray when the computer is turned off.





## Right View



#	Icon	Item	Description
1	N/A	PC Card slot eject button	Ejects the PC Card from the slot.
2		PC Card slot	Accepts one Type II PC Card.
3		5-in-1 card reader	Accepts Memory Stick (MS), Memory Stick Pro (MS PRO), MultiMediaCard (MMC), Secure Digital (SD) and xD-Picture Card (xD).
4		Three USB 2.0 ports	Connect to USB 2.0 devices (e.g., USB mouse, USB camera).
5	N/A	Ventilation slots	Enable the computer to stay cool, even after prolonged use.
6		DC-in jack	Connects to an AC adapter.

## Rear View



#	Icon	Item	Description
1		USB 2.0 ports	Connect to USB 2.0 devices (e.g., USB mouse, USB camera).
2		S-video/TV-out(NTSC/PAL)port	Connects to a television or display device with S-video input
2		External display (VGA) port	Connects to an external display device (e.g., external monitor, LCD projector).
3		Modem (RJ-11) port	Connects to a phone line.
4		Ethernet (RJ-45) port	Connects to an Ethernet 10/100/1000-based networks.
5	N/A	Battery	Powers the computer.

## Base View

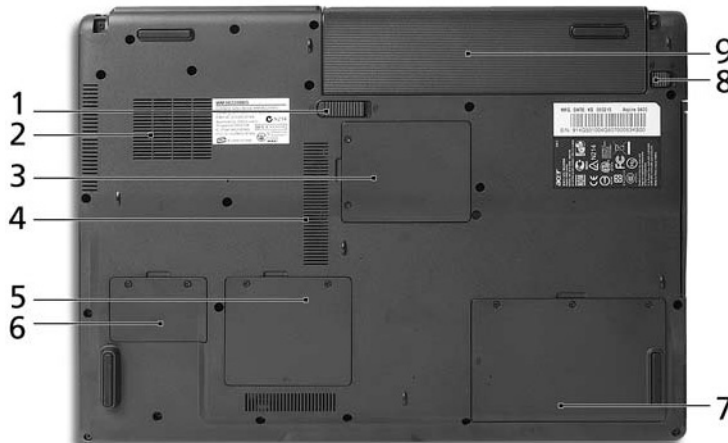

#	Icon	Item	Description
1	N/A	Battery release latch	Releases the battery for removal.
2	N/A	Cooling fan	Helps keep the computer cool. <b>NOTE:</b> Do not cover or obstruct the opening of the fan.
3	N/A	Mini PCI card bay	Houses the computer's Mini PCI card.
4	N/A	Ventilation slots	Enable the computer to stay cool, even after prolonged use.
5	N/A	Memory compartment	Houses the computer's main memory.

---

6	N/A	PCI Express Mini Card bay	Houses the computer's PCI Express Mini card.
7	N/A	Hard disk bay	Houses the computer's hard disk (secured with screws).
8	N/A	Battery lock	Locks the battery in position.
9	N/A	Battery bay	Houses the computer's battery pack.

# Using the Keyboard

The full-sized keyboard includes an embedded numeric keypad, separate cursor, lock, Windows, function and special keys.

## Lock keys and Embedded Numeric Keypad

The keyboard has three lock keys which you can toggle on and off.

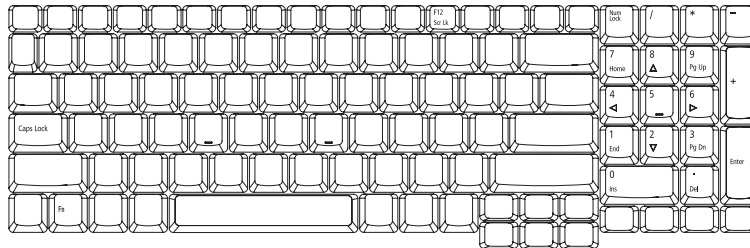









Lock	Description
Caps Lock	When Caps Lock is on, all alphabetic characters are typed in uppercase.
Num Lock <b>Fn + F11</b>	When Num Lock is on, the right hand side numeric keypad is in numeric mode. The keys function as a calculator (complete with the arithmetic operators +, -, *, and /). When Num Lock is off, the keys assume cursor and other shortcut functions.
Scroll Lock <b>Fn + F12</b>	When Scroll Lock is on, the screen moves one line up or down when you press the up or down arrow keys respectively. scroll Lock does not work with some applications.

The embedded numeric keypad functions like a desktop numeric keypad. It is indicated by small characters located on the upper right corner of the keycaps. To simplify the keyboard legend, cursor-control key symbols are not printed on the keys.

Desired access	Num Lock on	Num Lock off
Number keys on embedded keypad	Type numbers in a normal manner.	N/A
Cursor-control keys on embedded keypad	Hold <b>Shift</b> while using cursor-control keys.	Hold <b>Fn</b> while using cursor-control keys.
Main keyboard keys	Hold <b>Fn</b> while typing letters on embedded keypad.	Type the letters in a normal manner.

## Windows keys





The keyboard has two keys that perform Windows-specific functions.

Key	Icon	Description
Windows key		<p>Press alone. This key has the same effect as clicking on the Windows Start button. It launches the Start menu. It can also be used with other keys to provide a variety of functions:</p> <ul style="list-style-type: none"> <li> + <b>Tab</b>: Activates the next Taskbar button.</li> <li> + <b>E</b>: Opens the My Computer window.</li> <li> + <b>F1</b>: Opens Help and Support.</li> <li> + <b>F</b>: Opens the Find (All Files dialog box).</li> <li> + <b>R</b>: Opens the Run dialog box.</li> <li> + <b>M</b>: Minimizes all windows.</li> </ul> <p><b>Shift</b> +  + <b>M</b>: Undoes the minimize all windows action.</p>
Application key		This key has the same effect as clicking the right mouse button. It opens the application's context menu.

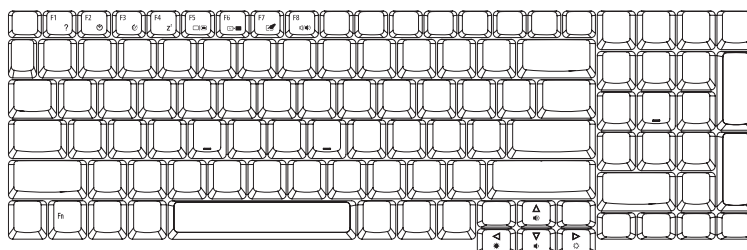







## Hotkeys

The computer employs hotkeys or key combinations to access most of the computer's controls like screen brightness, volume output and the BIOS utility. To activate hotkeys, press and hold the <Fn> key before pressing the other key in the hotkey combination.



Hot Key	Icon	Function	Description
<b>Fn + F1</b>		Hot key help	Displays help on hot keys.
<b>Fn + F2</b>		Acer eSetting	Launches the Acer eSettings in Acer Empowering Technology.
<b>Fn + F3</b>		Acer ePower Management	Launches the Acer ePower Management in Acer Empowering Technology.
<b>Fn + F4</b>		Sleep	Leads the computer to Sleep mode.



Hot Key	Icon	Function	Description
Fn + F5		Display toggle	Switches the display output between the display screen, external monitor (if connected) and both.
Fn + F6		Screen blank	Turns off the display screen backlight to save power. Press any key to return.
Fn + F7		Touchpad toggle	Turns the internal touchpad on and off.
Fn + F8		Speaker toggle	Turns the speakers on and off.
Fn + ↑		Volume up	Increases the sound volume.
Fn + ↓		Volume down	Decreases the sound volume.
Fn + →		Brightness up	Increases the screen brightness.
Fn + ←		Brightness down	Decreases the screen brightness.

## Special keys

You can locate the Euro symbol and the US dollar sign on the upper-center and/or bottom-right side of the keyboard.

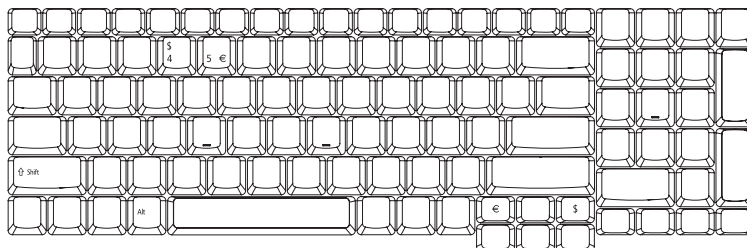

### The Euro Symbol

1. Open a text editor or word processor.
2. Either directly press the **Euro** key on the bottom-right side of the keyboard, or hold **Alt Gr** key then press the Euro symbol on the number **five** key.

**NOTE:** Some fonts and software do not support the Euro symbol. Please refer to [www.microsoft.com/typography/faq/faq12.htm](http://www.microsoft.com/typography/faq/faq12.htm) for more information.

### The US Dollar Sign

1. Open a text editor or word processor.

---

2. Either directly press the **\$** key on the bottom-right side of the keyboard, or hold **Shift** and then press the US dollar sign on the number **four** key.

**NOTE:** This function varies according to the language settings.







---

## Indicators

The computer provides an array of three indicators located above the keyboard, in addition to four indicators on the front cover. These indicators show the status of the computer and its components.



The front panel indicators are visible even when the computer cover is closed up.

Icon	Item	Description
	HDD	Indicates when the hard disk drive is active.
	Caps Lock	Lights up when Caps Lock is activated.
	Num Lock	Lights up when Num Lock is activated.
	Power	Lights when the computer is on.
	Battery	Lights when the battery is being charged.
	Bluetooth	Indicates the status of Bluetooth communication
	Wireless LAN	Indicates the status of wireless LAN communication

---

## Easy-launch Buttons

There are several conveniently located easy-launch buttons. They are one user-programmable button, web browser button, mail button, and Acer Empowering Key *e*. Press *e* to run the Acer Empowering Technology. Although the mail and web browser buttons are pre-set to E-mail and Internet programs, they can be redefined by users. To set the web browser, mail and programmable buttons, run the Acer Launch Manager.



Easy-launch button	Default application
<i>e</i>	Acer Empowering Technology (user-programmable)
Mail	E-mail application (user-programmable)
Web browser	Internet browser (user-programmable)
P	User-programmable

# Touchpad

The built-in touchpad is a pointing device that senses movement on its surface. This means the cursor responds as you move your finger across the surface of the touchpad. The central location on the palmrest provides optimum comfort and support.

## Touchpad Basics

Use the touchpad as follows:

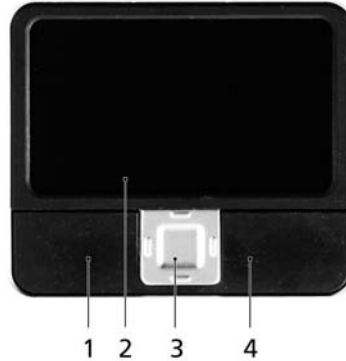

- ❑ Move your finger across the touchpad (2) to move the cursor.
- ❑ Press the left (1) and right (4) buttons located on the edge of the touchpad to perform selection and execution functions. These two buttons are similar to the left and right buttons on a mouse. Tapping on the touchpad (2) is the same as clicking the left button.
- ❑ Use the four-way scroll (3) button to scroll up or down and move left or right a page. This button mimics your cursor pressing on the right scroll bar of windows applications.

Function	Left button (1)	Right button (4)	Main touchpad (2)	Center button (3)
Execute	Quickly click twice.		Tap twice (at the same speed as double-clicking a mouse button).	
Select	Click once		Tap once	
Drag	Click and hold. Then slide your finger across the touchpad to drag the cursor over the selection.		Tap twice (at the same speed as double-clicking a mouse button); rest your finger on the touchpad on the second tap and drag the cursor.	
Access context menu		Click once		
Scroll				Click and hold to move up/down/left/right.

**NOTE:** Keep your fingers, as well as the surface of the touchpad dry and clean. The touchpad is sensitive to your finger movements: the lighter the touch, the better the response. Tapping hard will not increase

---

the touchpad's responsiveness.

**NOTE:** By default, vertical and horizontal scrolling is enabled on your touchpad. It can be disabled under Mouse settings in Windows Control Panel.

## Acer Empowering Technology

Acer's innovative Empowering Technology makes it easy to have access to the frequently used functions and manage the notebook. It features the following handy utilities:

- ❑ **Acer eDataSecurity Management** protects data with passwords and advanced encryption algorithms.
- ❑ **Acer eLock Management** limits access to external storage media.
- ❑ **Acer ePerformance Management** improves system performance by optimizing disk space, memory and registry setting.
- ❑ **Acer eRecovery Management** backs up and recovers data flexibly, reliably and completely.
- ❑ **Acer eSettings Management** accesses system information and adjusts settings easily.
- ❑ **Acer eNet Management** hooks up to location-based networks intelligently.
- ❑ **Acer ePower Management** extends battery power via versatile usage profiles.
- ❑ **Acer ePresentation Management** connects to a projector and adjusts display settings conveniently.



For more information, press the *e* key to launch the Empowering Technology menu, then click on the appropriate utility and select the Help function.

## Acer eDataSecurity Management

Acer eDataSecurity Management is a handy file encryption utility that protects the files from being accessed by unauthorized persons. It is conveniently integrated with Windows Explorer as a shell extension for quick and easy data encryption and decryption and also supports on-the-fly file encryption for MSN Messenger and Microsoft Outlook.

There are two passwords that can be used to encrypt and decrypt a file: the supervisor password and the file-specific password. The supervisor password is a “master” password that can decrypt any file on the system. The file-specific password is assigned when you encrypt each individual file.

Acer eDataSecurity Management setup wizard will prompt for a supervisor password and default file-specific password. This file-specific password will be used to encrypt files by default, or you can choose to enter your own file-specific password when encrypting a file.

**NOTE:** The password used to encrypt a file is the unique key that the system needs to decrypt it. If you lose the password, the supervisor password is the only other key capable of decrypting the file. **If you lose both passwords, there will be no way to decrypt the encrypted files! Be sure to safeguard all related password.**





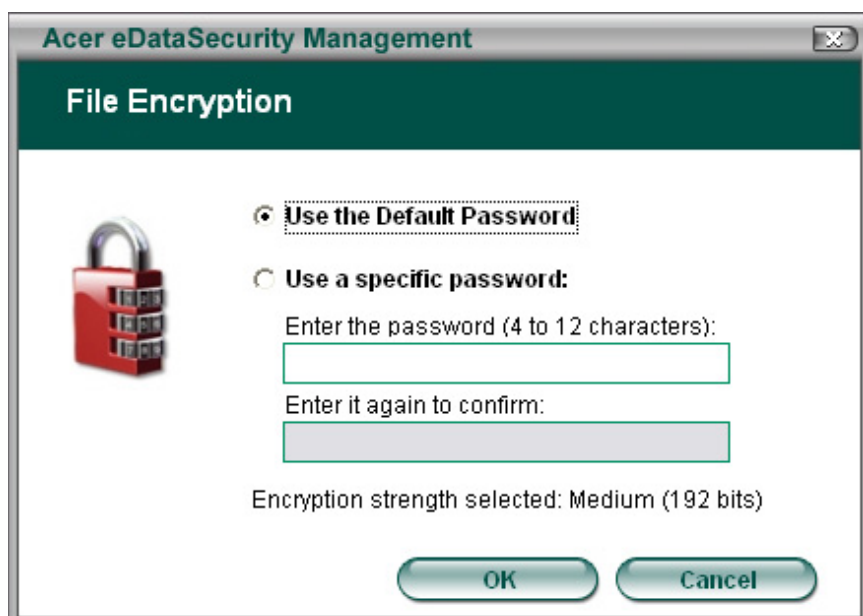

## Acer eLock Management

Acer eLock Management is a security utility that allow you to lock up your removable data, optical and floppy drives to ensure that data can not be stolen while your notebook is unattended.

- ❑ Removable data devices: includes USB disk drives, USB pen drives, USB flash drives, USB MP3 drives, USB memory card readers, IEEE 1394 disk drives and any other removable disk drives that can be mounted as a file system when plugged into the system.
- ❑ Optical drive devices: includes any kind of CD-ROM or DVD-ROM drives.
- ❑ Floppy disk drives: 3.5-inch disks only.

To activate Acer eLock Management, a password must be set at first. Once set, you may apply locks to any of the three kinds of devices. The lock(s) will be set without any reboot necessary, and will remain locked after rebooting, until unlocked.

If you do not set a password, Acer eLock Management will reset back to the initial status with all locks cancelled.

**NOTE: If you lose the password, there is no method to reset it except by reformatting the notebook or taking the notebook to an Acer Customer Service Center.** Be sure to remember or write down the password.

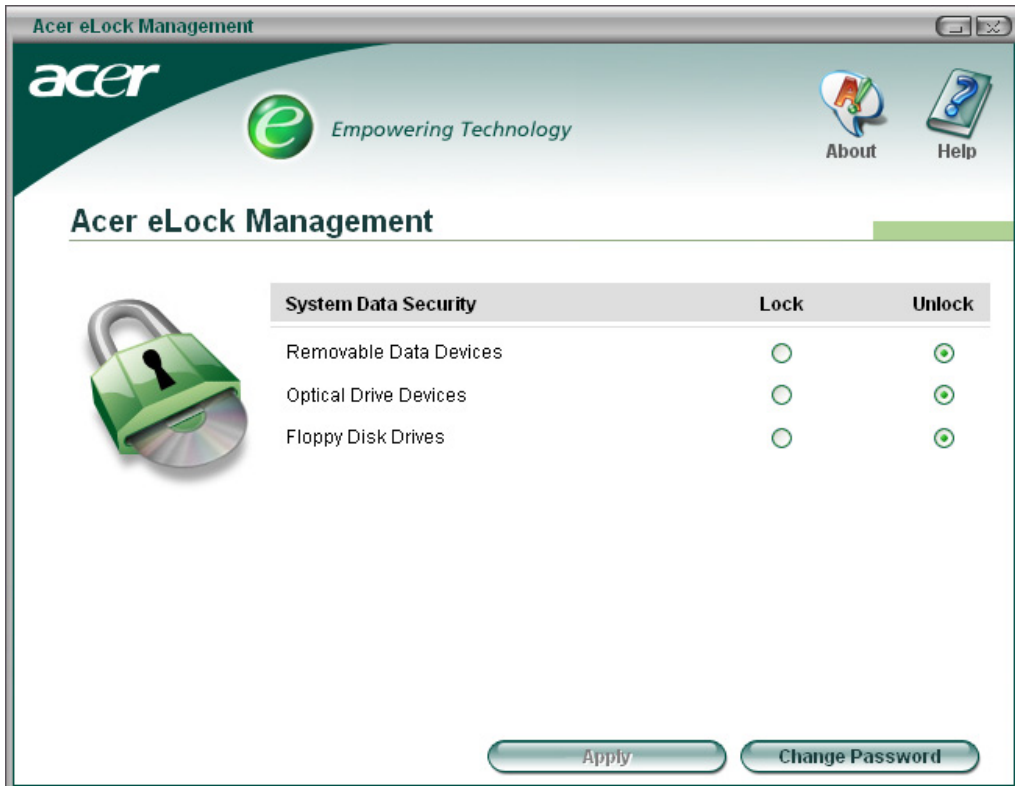

## Acer ePerformance Management

Acer ePerformance Management is a system optimization tool that boosts the performance of the Acer notebook. It provides you with the following options to enhance overall system performance:

- Memory optimization: releases unused memory and checks memory usage.
- Disk optimization: removes unneeded items and files.
- Speed optimization: improves the usability and performance of the Windows XP system.

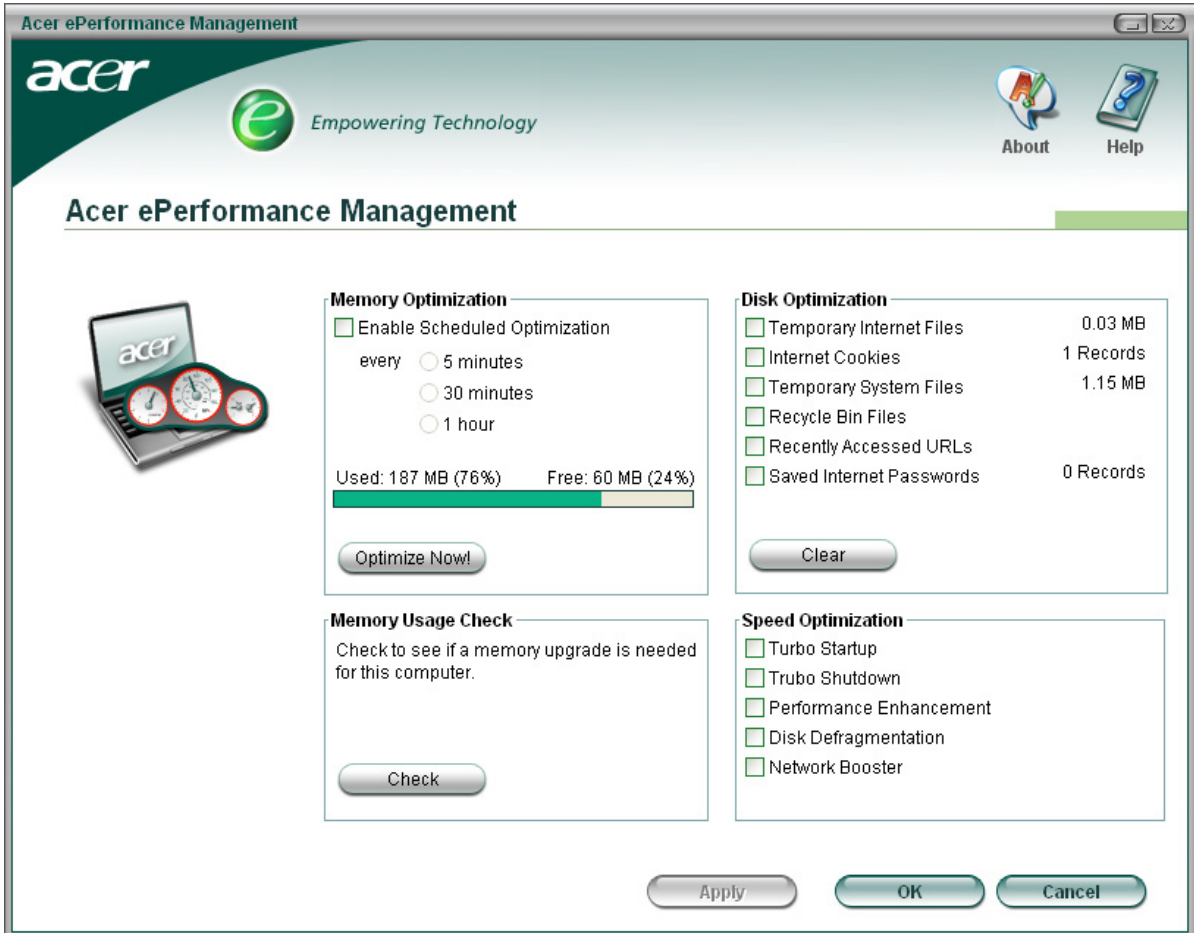

## Acer eRecovery Management

Acer eRecovery Management is a powerful utility with the need for recovery disks provided by the manufacturer. The Acer eRecovery Management utility occupies space in a hidden partition on the system's HDD. User-created backups are stored on D:\ drive. Acer eRecovery Management provides:

- Password protection
- Recovery of applications and drives
- Image or data backup:
  - Backup to HDD (set recovery point)
  - Backup to CD or DVD
- Image or data recovery tools:
  - Recovery from a hidden partition (factory defaults)
  - Recovery from the HDD (most recent user-defined recovery point)
  - Recovery from CD or DVD



**NOTE:** If the computer did not come with a Recovery CD or System CD, please use Acer eRecovery Management's "System backup to optical disk" feature to burn a backup image to CD or DVD. To ensure the best results when recovering the system using a CD or Acer eRecovery Management, detach all peripherals (except external Acer ODD, if equipped), including the Acer ezDock.

## ***Acer eSettings Management***

Acer eSettings Management allows you to inspect hardware specification and to monitor the system health status. Furthermore, Acer eSettings Management enables you to optimize your Windows operating system, so your computer runs faster, smoother and better.

- ❑ Provides a simple graphical user interface for navigating through the program effortlessly.
- ❑ Displays general system status and advanced monitoring for power users.
- ❑ Logs when a hardware component has been removed or replaced.
- ❑ Permits you to migrate personal settings.
- ❑ Keeps a history log of all alerts that were previously issued.



## Acer eNet Management

Acer eNet Management helps you to quickly and easily connect to both wired and wireless networks in a variety of locations. To access this utility, either click on the “Acer eNet Management” icon on the notebook, or start the program from the Start menu. You also have the option to set Acer eNet Management to start automatically when you boot up the PC.

Acer eNet Management automatically detects the best settings for a new location, while offering you the freedom to manually adjust the settings to match your needs, simply by right clicking on the icon in the task bar.

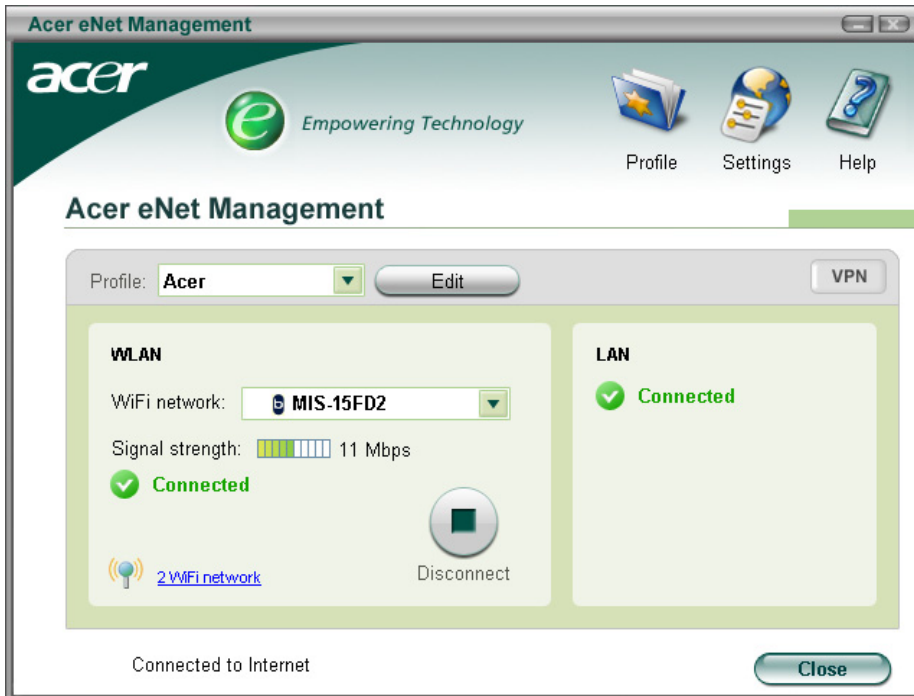

Acer eNet Management can save network settings for a location to a profile, and automatically apply the appropriate profile when you move from one location to another. The settings stored include network connection settings (IP and DNS settings, wireless AP details, etc.), as well as default printer settings. The security and safety concerns mean that Acer eNet Management does not store username and password information.

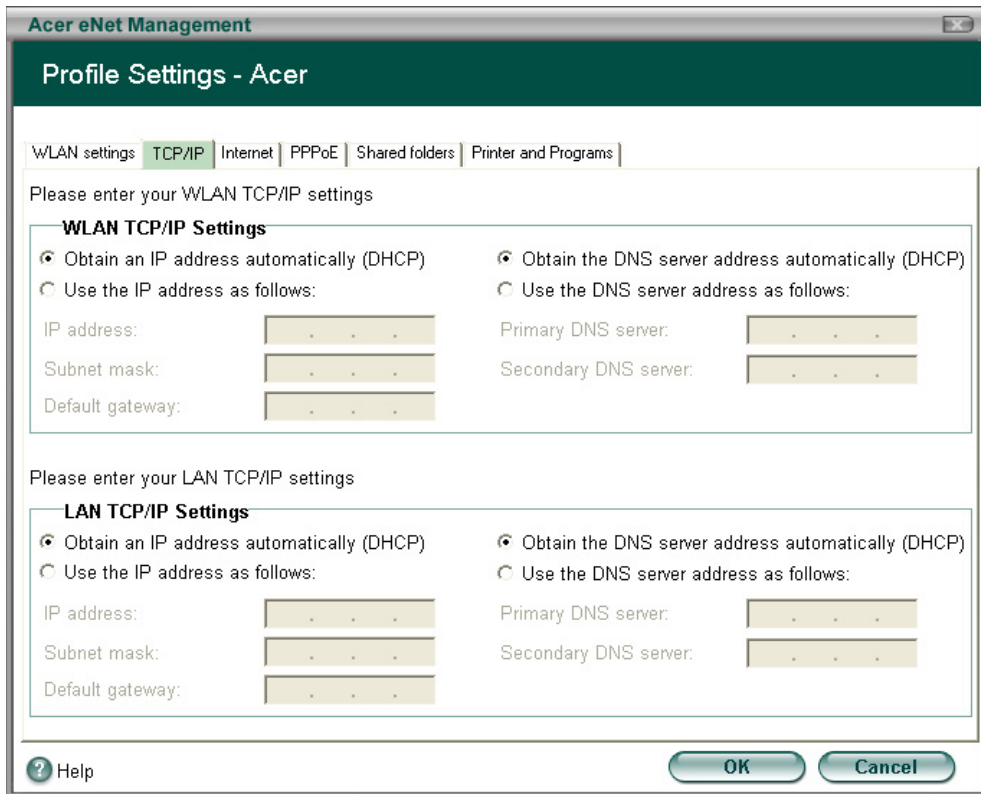

## Acer ePower Management

Acer ePower Management features a straightforward user interface. To launch it, select Acer ePower Management from the Empowering Technology interface, or double click the Acer ePower Management icon in the task tray.

### AC mode

The default setting is “Maximum Performance.” You can adjust CPU speed, LCD brightness and other settings, or click on buttons to turn the following functions on or off: Wireless LAN, Bluetooth, CardBus, Memory Card, Audio, and Wired LAN.

### DC mode

To suit your usage, there are four pre-defined profiles: Entertainment, Presentation, Word Processing, and Maximum Battery. Or, you can define up to three of your own profiles.

### Battery status

For real-time battery life estimates based on current usage, refer to the panel on the lower left side of the window.

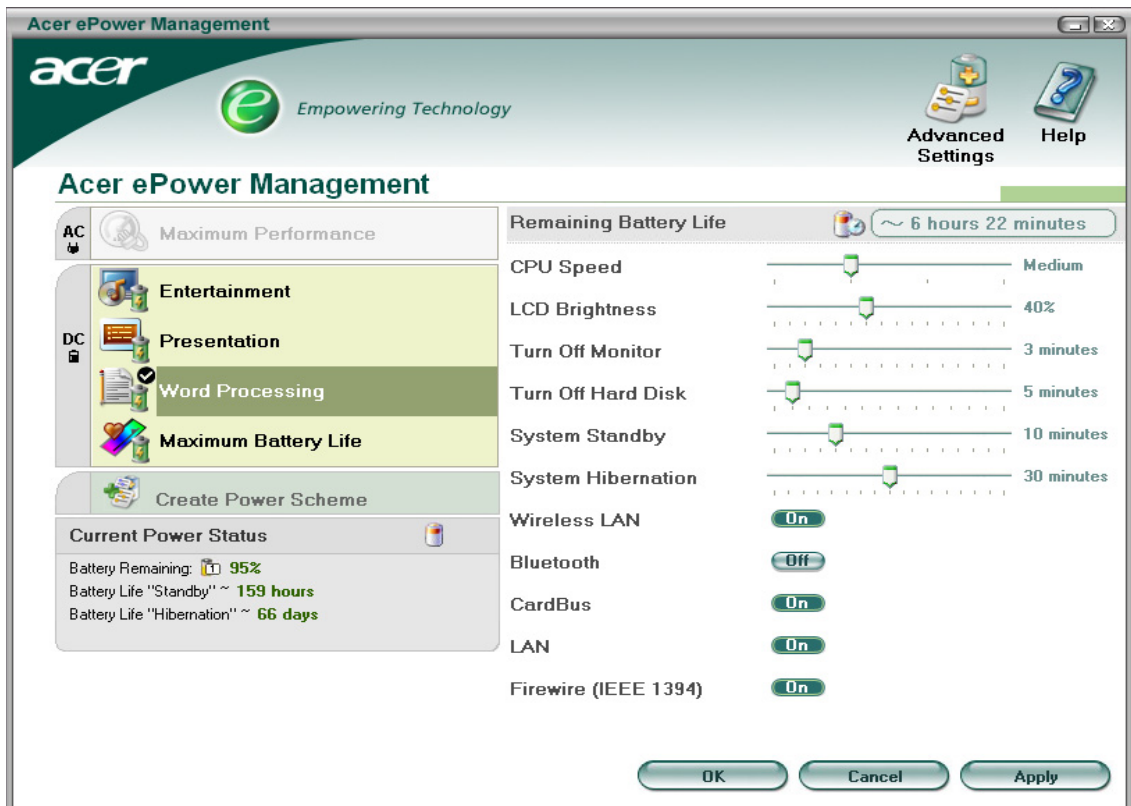

You can also click “Advanced settings” to:

- Set alarms.
- Reload factory defaults.
- Select what actions will be taken when the cover is closed, and set passwords for accessing to the system after Hibernation or Stand-by.



- View information about Acer ePower Management.

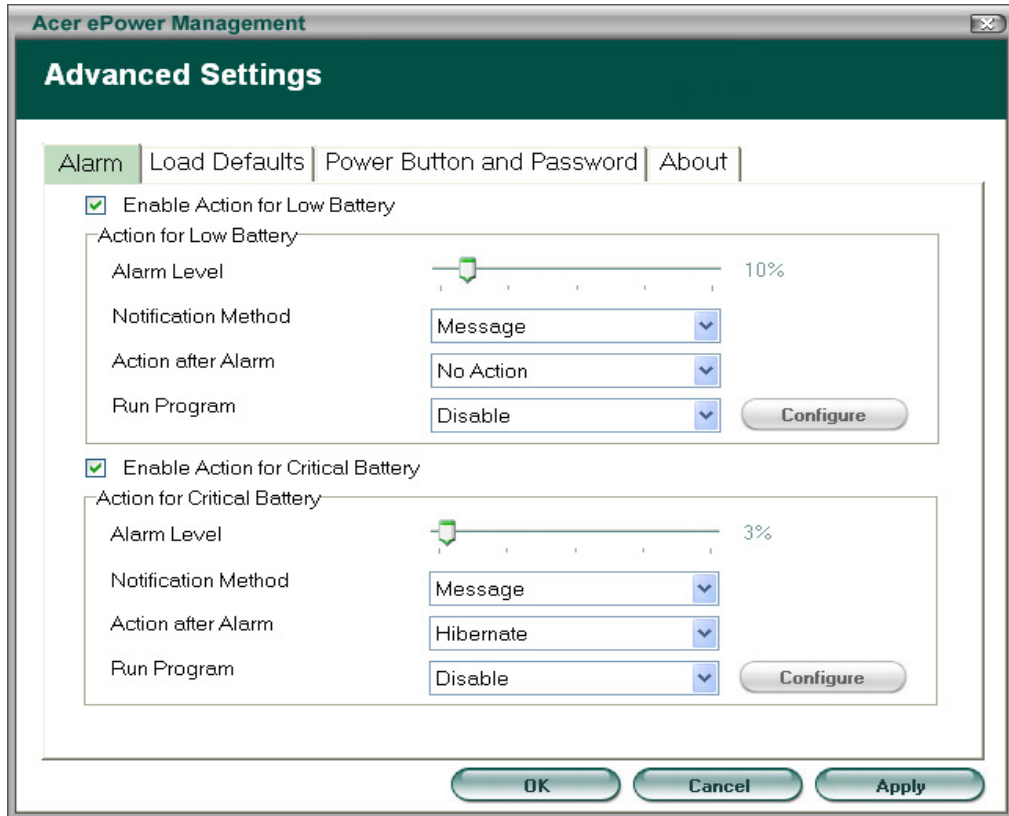

---

## ***Acer ePresentation Management***

Acer ePresentation Management lets you select from two of the most common projector resolution: XGA and SVGA.

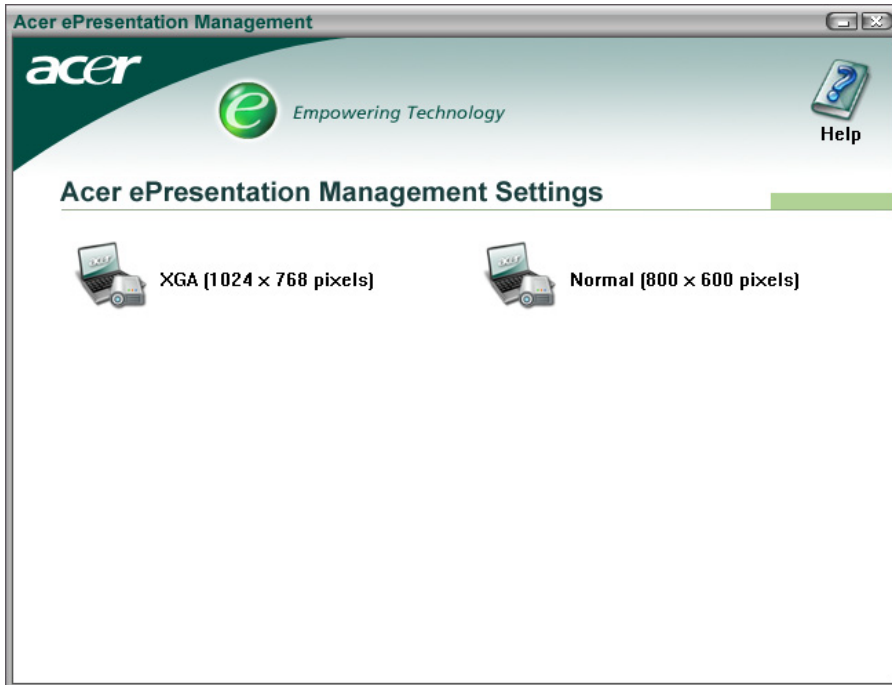

---

## Acer OrbiCam

The Acer OrbiCam is a 1.3 megapixel CMOS camera appropriately mounted on the top of the LCD panel. The camera's 225-degree ergonomic rotation allows you to capture high-resolution photos or videos up front or at the back of the LCD panel. The Acer OrbiCam fully supports the Acer Video Conference technology so that you can transmit the best video quality over an instant messenger service.

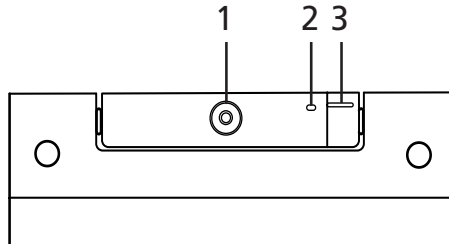

No.	Item
1	Lens
2	Power indicator
3	Rubber grip (selected models only)

### Rotating the Acer OrbiCam

The Acer OrbiCam rotates 225 degrees counterclockwise to achieve the desired angle. Refer to the illustrations below:

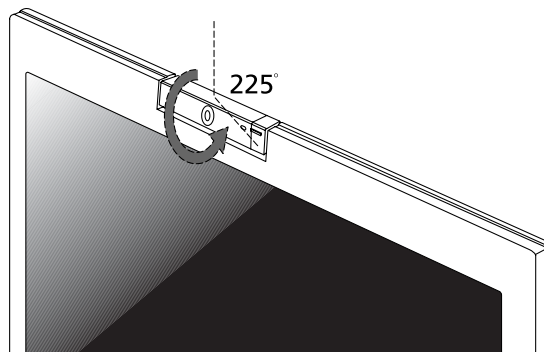

For your convenience, the camera snaps 45 degrees to match the position of your face in front in back of the LCD panel.

**NOTE:** Do not rotate the camera clockwise to prevent it from the damage.

---

## Launching the Acer OrbiCam

To launch the Acer OrbiCam, double click on the Acer OrbiCam icon on the screen. or Click Start > All programs > Acer > Acer OrbiCam. The Acer OrbiCam capture windows window appears as below:

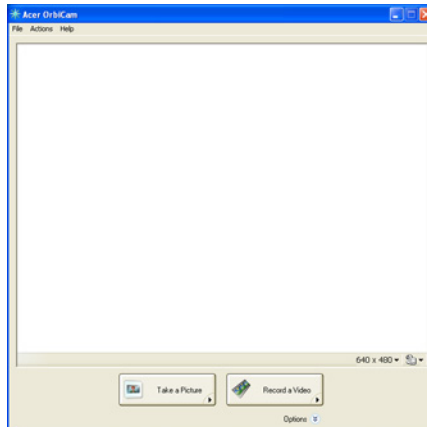

## Changing the Acer OrbiCam settings

### Resolution

To change the capture resolution, click the displayed resolution at the bottom right corner of the capture window, then select the desired resolution. Setting the camera resolution to 640 x 480 or larger does not change the capture window size.

### Options

Click Options to display the Window, Preview, and Folder tabs. Use the options to change the capture window size, preview settings, and the folder for captured photos or videos.

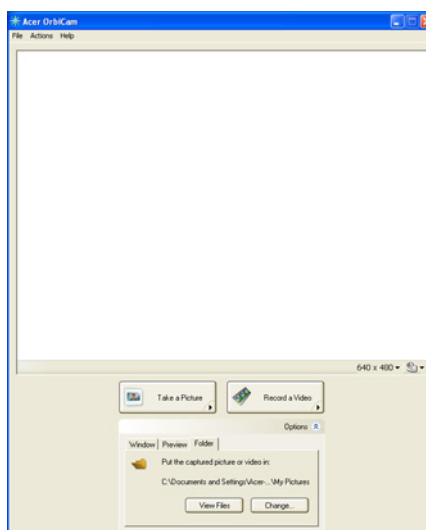

---

## Camera Settings

- Basic settings: Click the Camera Settings icon on the bottom right corner of the capture display, then select Camera Settings from the pop-up menu. You can adjust the Video, Audio, and Zoom/Face tracking options from this window.



- Capture settings: From the Camera Settings window, click the Driver Settings button. The Properties window will appear.

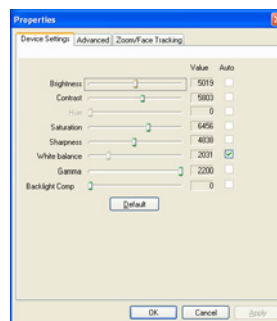

- Device Settings allows you to change the camera brightness, contrast, hue, saturation, sharpness, etc.
- Advanced Settings allows you to achieve gain control, implement image mirror, select image enhancements and anti-flicker settings, and turn on/off the camera indicator.
- Zoom/Face Track Settings allows you to adjust the zoom level and turn the face tracking feature on or off.

## Capturing photos or videos

To capture a photo or a video clip, rotate the Acer OrbiCam to get the desired angle, then click the Take a Picture or Record a Video button. The Windows Picture and Fax Viewer or the Windows Media Player automatically launches to display or play a preview of the photo/video clip.

**NOTE:** By default, all photos and videos are saved in the My Pictures and My Videos folder.

## Using the Acer OrbiCam as webcam

The Acer OrbiCam is automatically selected as the capture device of any instant messenger (IM) application. To use the Acer OrbiCam as a webcam, open the IM service, then select the video/webcam feature. You can now broadcast from your location to an IM partner anywhere in the world.

## Enabling the Acer VisageON

The Acer VisageON technology comes with two features: Face tracking and Video effects (selected models only). The Face Tracking feature tracks your head movement and automatically centers your face in the capture window. The video effects feature allows you to select and apply an effect to your video transmissions.

**NOTE:** The face tracking feature is not capable of centering your face beyond the capture window frame. Minimal head movements are tracked more efficiently.

To enable the Acer VisageON:

1. Right click on this icon, then select VisageON from the pop-up menu.

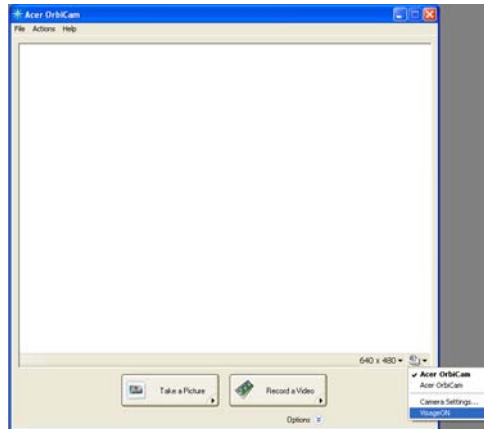

The VisageON window appears as below:



2. Select and apply a video effect in the left section of the VisageON window. Change the face tracking settings and options in the right section.

## Using the face tracking feature

To use the face tracking feature:

1. Click the left icon down arrow button, then select Single User or Multiple Users from the pop-up menu. For multiple users, the face tracking feature automatically centers all the users' face in the capture window, otherwise the utility centers the face of the user closest to the camera.

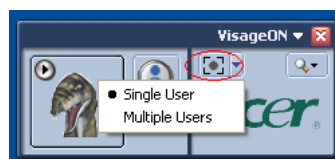

2. Click the right icon to zoom in/out or reset the current view.

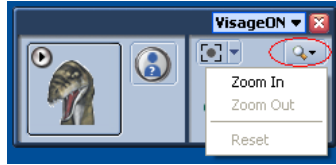

3. Click VisageON to display a menu that allows to change the configuration of the camera, face tracking and video effects settings.

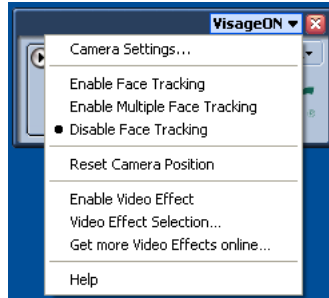

### Using video effects (selected models only)

The Video Settings section allows you to select an avatar or accessory video effect from the list. To select an effect:

1. Click the encircled icon to display the available video effects. The Video Effect Selection window appears as below:

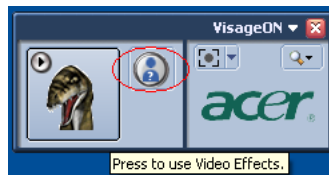

- 
2. Click on a video effect to use. The selected effect appears in the video effects section of the VisageON window.

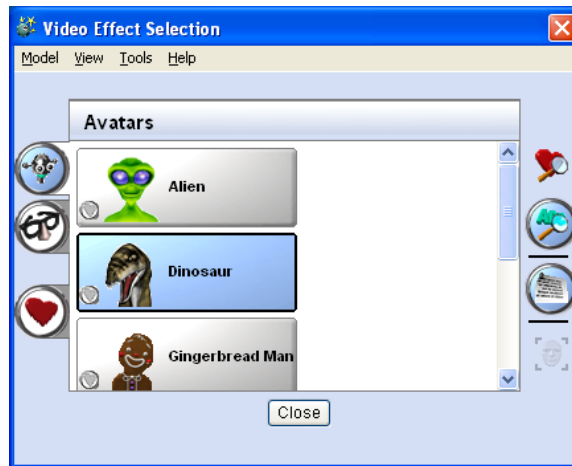

**NOTE:** When using avatars, you may have to calibrate the face points to achieve better tracking. Follow screen instructions in the VisageON to continue.

**NOTE:** You may use video effects when using the camera for IM chat/video sessions or call conferences.



# Using the System Utilities

**NOTE:** The system utilities work under Microsoft Windows XP only.

## ***Acer GridVista (dual-display compatible)***

**NOTE:** This feature is only available on certain models.

To enable the dual monitor feature of the notebook, first ensure that the second monitor is connected, then select Start, Control Panel, Display and click on Settings. Select the secondary monitor (**2**) icon in the display box and then click the check box **Extend my windows desktop** onto this monitor. Finally, click Apply to confirm the new settings and click OK to complete the process.

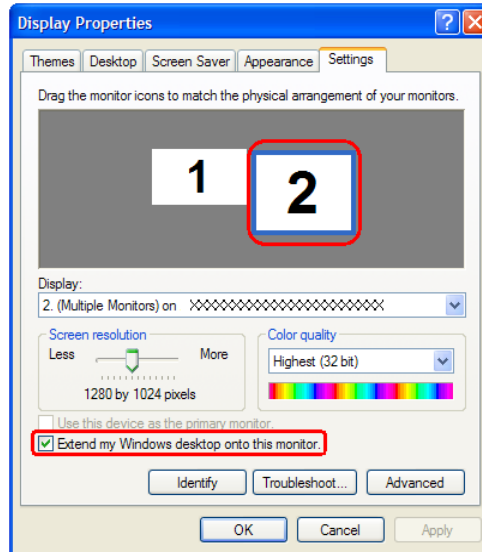

Acer GridVista is a handy utility that offers four pre-defined display settings so you can view multiple windows on the same screen. To access this function, please go to Start > All Programs and click on Acer GridVista. You may choose any one of the four display settings indicated below:



Acer GridVista is dual-display compatible, allowing two displays to be partitioned independently. Acer GridVista is simple to set up:

1. Run Acer GridVista and select your preferred screen configuration for each display from the task bar.
2. Drag and drop each window into the appropriate grid.
3. Enjoy the convenience of a well-organized desktop.

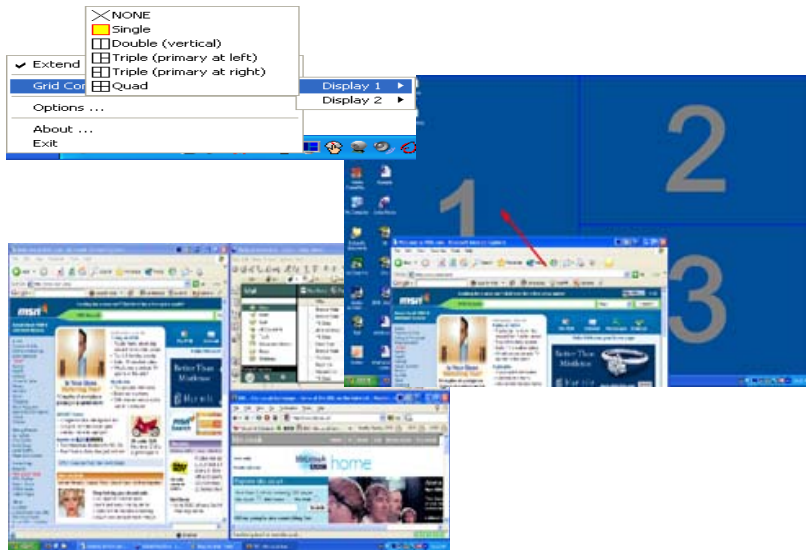

**NOTE:** Please ensure that the resolution setting of the second monitor is set to the manufacturer's recommended value.

## ***Launch Manager***

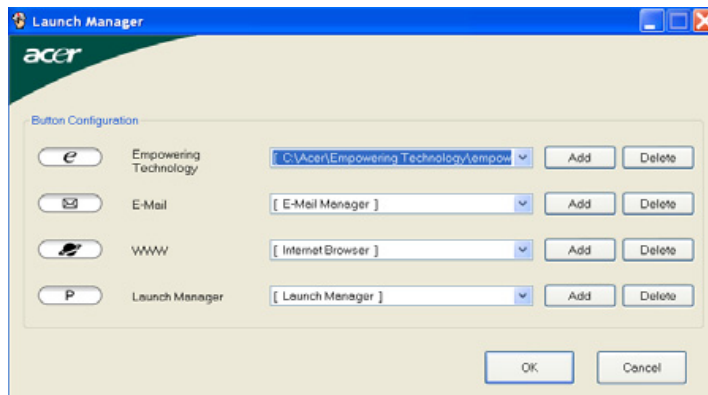

Launch Manager allows you to set the four easy-launch buttons located above the keyboard. You can access the Launch Manager by clicking on Start > All Programs > Launch Manager to start the application.

# Norton AntiVirus

Norton AntiVirus is an anti-virus software that finds and repairs infected files, and protects against viruses to keep your computer data safe and secure.

## *How do I check for viruses?*

A Full System Scan scans all files on your computer. To perform a system scan:

1. Start Norton Antivirus: Double click on the **Norton AntiVirus** icon on the desktop or click on the **Start** menu in the Windows task bar, highlight **Programs**, and select **Norton Antivirus**.
2. In the Norton Antivirus main window, click **Scans**.

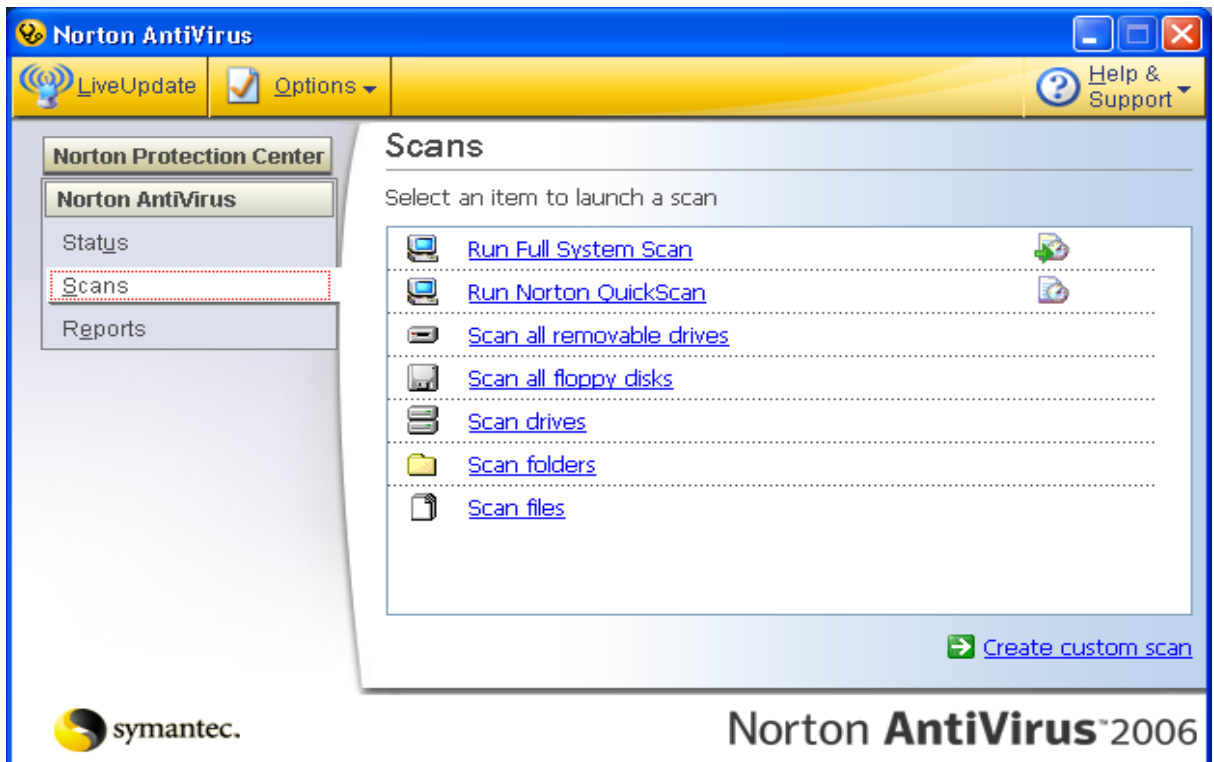

3. In the **Scans** panel, click **Run Full System Scan**.
4. When the scan is complete, a scan summary appears. Click **Finished**.

You can schedule customized virus scans that run unattended on specific dates and times or at periodic intervals. If you are using the computer when the scheduled scan begins, it runs in the background so that you do not have to stop working.

For more information, please refer to the Norton AntiVirus Help menu.

# Hardware Specification and Configuration

## Processor

Item	Specification
CPU type	AMD™ Turion 64 X2 Mobile Technology TL-52/TL-56/TL-60 (1.6/1.8/2GHz, 2 x 512 KB L2 cache), TL-50 (1.6GHz, 2 x 256 KB L2 cache) AMD Sempron™ Mobile Technology 3200+/3500+(1.6/1.8 GHz, 512 KB L2 cache), 3400+ (1.8 GHz, 256 KB L2 cache)
Package	Socket S1, 638-pin lidless Micro-PGA
Core voltage	1.2875V (highest frequency mode) to 0.8375V (low frequency mode)
Feature	<ul style="list-style-type: none"> <li><input type="checkbox"/> Dual-core processing</li> <li><input type="checkbox"/> Simultaneous 32 bit and 64 bit Windows® support</li> <li><input type="checkbox"/> AMD PowerNow!™, AMD HyperTransport™, Enhanced Virus Protection2 and 3DNow! professional technology</li> </ul>
Bus speed	Power optimized HyperTransport™ technology up to 1600MHz, full duplex
On-die second (L2) cache	2x512KB or 2x256KB

## System Board Major Chips

Item	Specification
System core logic	nVidia C51MV + MCP51
Super I/O controller	NS87381
Audio controller	Codec ALC883
Video controller	<ul style="list-style-type: none"> <li>• nVidia GeForce Go 6100 integrated graphics</li> <li>• nVidia GeForce Go7300/7600 SE</li> </ul>
HDD controller	MCP51
Keyboard controller	ENE KB3910
PCMCIA controller	PCI 7412
soDIMM controller	C51MV

## Hard Disk Drive

Seagate				
Model	ST9120821A ST9120824A	ST9100824A ST9100825A	ST98823A ST980829A	ST96812A
Drive Specification				
Formatted Gbytes (512 bytes/sector)	120	100	80	60
Physical read/write head	4	4	3	3
Discs	2	2	2	2

## Hard Disk Drive

Seagate	
Spindle Speed (RPM)	4200 (ST9120824A, ST9100825A, ST980829A) 5400 (ST9120821A, ST9100824A, ST98823A, ST96812A)
Internal transfer rate (Mbytes/sec. max.)	56.25 (ST9120824A, ST9100825A, ST980829A) 48.25 (ST9120821A, ST9100824A, ST98823A, ST96812A)
I/O data transfer rate (Mbytes/sec. max.)	100
ATA data transfer mode supported	PIO modes 0-4; Multiword DMA modes 0-2; Ultra DMA modes 0-5
Bytes per sector	512
Average latency (msec)	5.6
Average seek, read (msec. typical)	12.5
Average seek, write (msec. typical)	14.5
Cache buffer	8 Mbytes
Interface	Serial ATA
Startup current (typical, peak)	+5V: 1.1 amps
Ambient temperature	5 to 55°C (operating), -40 to 70°C (nonoperating)
Temperature gradient (°C per hour max.)	20°C (operating), 30°C (nonoperating)
Relative humidity	5% to 90% (operating), 5% to 95% (nonoperating)
Relative humidity gradient	30% per hour max.
Drive acoustics, sound power (bels) idle	2.4 (typical), 2.6 (max)
Shock, operating (Gs max. at 0.5 msec.)	250
Shock, nonoperating (Gs max. at 2 msec.)	800
Vibration, operating	1.0 G (0 to peak, 5-500 Hz)
Vibration, nonoperating	5 Gs (0 to peak, 5-500 Hz)
Nonrecoverable read errors	1 per 10 <sup>14</sup> bits read, max.
Seek power (typical)	2.20 watts
Read/write power (typical)	Read: 1.90 watts; Write: 2.30 watts
Idle mode, lower power (typical)	0.80 watts
Standby mode	0.28 watts
Sleep mode	0.28 watts
Voltage tolerance	+5.0V +/- 5%

## BIOS

Item	Description
BIOS vendor	Phoenix
System BIOS version	V1.00

## BIOS

Item	Description
Feature	<ul style="list-style-type: none"><li>• Suspend to RAM (S3) / Disk (S4)</li><li>• Support boot option: HDD / Removable device (media bay device) / all USB ports</li><li>• Support SMBIOS 2.3, PCI2.2, WFM2.0</li><li>• ACPI 2.0/3.0 compliance with Intel Speedstep Support C1, C2, C3, C4 and S3, S4 for mobile CPU</li><li>• Wake on LAN from S3</li><li>• Wake on LAN from S4 in AC mode</li><li>• Package: 40-pin TSOP</li><li>• ROM type: one MB CMOS Boot block Flash Memory</li></ul>

## System Memory

Item	Description
Chipset	C51MV
Feature	<ul style="list-style-type: none"><li>• DDR2 533/667 MHz SDRAM memory interface design</li><li>• Two DDR SODIMM slots</li><li>• Maximum memory up to 4GB (with two 2GB SODIMM)</li><li>• Dual Channel</li></ul>

## VGA

Item	UMA	Discrete
Chip	nVidia GeForce Go 6100	nVidia GeForce Go 7300/7600 SE
VRAM	64MB	up to 256MB

## PCMCIA

Item	Description
PCMCIA controller	TI7412
Card type support	Type II
Number of slot	One
Feature	Five-in-one Card Reader: Memory Stick (MS), Memory Stick Pro (MS PRO), MultiMediaCard (MMC), Secure Digital (SD) and xD-Picture Card (xD).

## Audio

Item	Description
Audio controller	Realtek ALC833 Codec

## Audio

Item	Description
Feature	<ul style="list-style-type: none"><li>• Built-in</li><li>• Stereo</li><li>• SNR &gt; 85, high-performance DACs with 95dB SNR (A-Weighting), ADCs with 85dB SNR (A-Weighting)</li><li>• Internal Microphone</li><li>• Two speakers, at least 1.5W / 30cc for each</li><li>• 2* digital microphone array</li><li>• VoIP function support</li><li>• Universal jack function support</li></ul>

## LAN

Item	Description
LAN controller	Realtek RTL8211B
Feature	<ul style="list-style-type: none"><li>• 10 / 100 / 1000 Mbps PCI LAN</li><li>• Jumbo frame support</li><li>• WOL from S5 support</li><li>• File deployment support</li></ul>
Connector type	RJ-45

## Wireless LAN

Item	Description
Card type	Mini-PCI
Mode	<ul style="list-style-type: none"><li>• 802.11b/g</li><li>• Built-in two antenna (placed on the top of LCD on the side of LCD latch, the wire of antenna can not be placed under the panel)</li></ul>
Support	Wi-Fi, WPA2, WMM, CCX V3/V4

## Modem

Item	Description
Controller	MCP51
Data modem data baud rate (bps)	56K
Modem/bluetooth protocol supported	<ul style="list-style-type: none"><li>• V.90/V.92 AC-Link modem with PTT approval</li><li>• Wake-on-Ring ready</li><li>• CISPR22 application</li></ul>
Connector type	RJ-11

## Keyboard

Item	Description
Controller	ENE KB3910
Model name	New Acer Ergo Keyboard

## Keyboard

Item	Description
Feature	<ul style="list-style-type: none"> <li>• 105 / 106 keys standard keyboard</li> <li>• Touch pad with 4-way integrated scroll button</li> <li>• Windows keys and application keys support</li> <li>• Standard pitch, 2.5 mm travel length</li> <li>• Hotkey controls</li> <li>• Embedded numeric keypad</li> <li>• Multi-language support</li> <li>• Spill-proof</li> <li>• Four easy-launch buttons: Internet browser, E-mail with LED, Acer Empowering, one user-programmable button</li> </ul>

## Battery

Item	Specification
Vendor & model name	Panasonic / Sanyo / Sony
Battery Type	Li-Ion
Pack capacity	8-cell: 2400 mAh 6-cell: 2000 mAh

## System Power Management

Legacy Mode	ACPI Mode
Off	<ul style="list-style-type: none"> <li>• Mech. Off (G3): All devices in the system are turned off completely.</li> <li>• Soft Off: (G2/S5): All devices in the system are turned off completely by OS shutdown.</li> </ul>
On	<ul style="list-style-type: none"> <li>• Working (G0/S0): Individual devices such as the CPU and hard disk may be power-managed in this state.</li> <li>• <b>S3</b> Sleeping State: CPU set power down, VGA suspend, PCMCIA suspend, Audio power down, HDD power down, CD-ROM power down, Super I/O low power mode.</li> <li>• <b>S4</b> Sleeping State: It is also called hibernation state. The system saves all system setting and data onto disk before the whole system is powered off.</li> </ul>

## LCD

Item	Specification			
Vendor and Model name	Samsung LTN170WX-L05-H	QDI QD17TL02-06	AUO B170PW03 V4	LG LP171WP4-TL01
Screen Diagonal (mm)	17.1" WXGA	17.1" WXGA	17.1" WXGA	17.1" WXGA
Active area	367.20 (W) x 229.50 (H)	367.20 (W) x 229.50 (H)	367.20 (W) x 229.50 (H)	367.20 (W) x 232.9 (H)
Display resolution	1440 x 3 (RGB) x 900	1440 x 3 (RGB) x 900	1440 x 3 (RGB) x 900	1440 x 3 (RGB) x 900
Display mode	normally white	normally white	normally white	normally white



## LCD

Item	Specification			
Surface treatment	non-glare type (1) glare type (H)	hard coating (3H) glare type	glare type	non-glare type
Pixel arrangement	RGB vertical stripe	RGB vertical stripe	RGB vertical stripe	RGB vertical stripe
Pixel pitch (mm)	0.255 (per one triad) x 0.255	0.255 (per one triad) x 0.255	0.255 (per one triad) x 0.255	0.255 (per one triad) x 0.255
Typical white luminance (cd/m <sup>2</sup> ) also called brightness	200 (typical)	200 (center typical)	200 (typical)	200 (typical)
Contrast ratio	350 (typical)	300 : 1 (Min)	300 : 1 (typical)	350 (Min)
Respond time (optical rise time + fall time) (msec.)	25 (typical) 35 (max.)	25 (typical)	16 (typical)	25 (typical)
Normal input voltage of power supply	+3.3V (typical)	+3.3V (typical)	+3.3V (typical)	+3.3V (typical)
Power consumption (watt)	4.320 (typical)	4.7 (typical)	8 (max.)	4.78 (typical)
Weight	750g	750g	700g	670g
Physical size (mm)	382.7 (W) x 245 (V) x 7.0 (T)	382.7 (H) x 245.1 (V) x 7.0 (T)	382.2 (W) x 244.5 (H) x 6.6 (D)	382.2 (W) x 244.5 (H) x 6.5 (D)
Electrical interface	2 channel LVDS	2 channel LVDS	2 channel LVDS	2 channel LVDS
Color support	Native 262K colors	Native 262K colors	Native 262K colors	Native 262K colors

## AC Adaptor

Item	Specification	
Model name	LiteOn PA-1900-04 WR	Delta 90W ADP-90SB BBAAF
Input feature		
Rated voltage	for 100Vac or 240Vac input AC voltage	for 100Vac or 240Vac input AC voltage
Input voltage range	from 90Vac to 264Vac	from 90Vac to 265Vac
Rated frequency	for 50Hz or 60Hz	for 50Hz or 60Hz
Frequency range	from 47Hz to 63Hz	from 47Hz to 63Hz
Steady AC current	less than 1.5A rms at 100Vac input and maximum load	less than 1.5A rms at 100Vac input and maximum load
Output feature		
Rated voltage	19V	19V
Voltage range	18.05V to 20V	from 18.2V to 19.8V
Rated power	90 W	90 W

Item	Specification	
Output ripple and noise	less than 300mVp-p	less than 300mVp-p
Turn on delay time	within two seconds at 115 Vac input voltage	within two seconds at 115 Vac input voltage
Temperature	Operating: 0 to 40°C Non-operating: -31 to 60°C	Operating: 0 to 40°C Non-operating: -31 to 60°C

#### 24X Combo Drive Interface

Item	Specification	
Vendor & model name	PHILIPS SCB5265	LITEON SSC-2485K
Performance Specification		
Transfer rate (KB/sec.)	Sustained: DVD: Max 10.56Mbytes/sec. CD: 3600Kbytes/sec.	Sustained: DVD: Min 10.15Mbytes/sec. CD: 3500 Kbytes/sec.
Access Time (Typical)	DVD: Random Access: 125 ms DVD: Full Stroke: 165ms CD: Random Access:105ms CD: Full Stroke:160ms	DVD: Random Access: 100 ms DVD: Full Stroke: 190ms CD: Random Access:95ms CD: Full Stroke:180ms
Buffer Memory	2MB	2MB
Interface	Compliant to ATA/ATAPI-5	ATA/ATAPI-6, MMC-3 and SFF8090 Ver5, Revision 1.2.
Applicable disc format	DVD (read): DVD 5, 9, 10, 18, DVD-ROM, DVD-Video, DVD-R 3.95G, DVD-R 4.7G, DVD-RW, DVD+R, DVD+RW, Multi-Border DVD-R/DVD-RW, Multi-Session DVD+R, DVD+RW, DVD-RAM CD (write): CD-DA, CD ROM Mode-1, CD-ROM/XA Mode-2 Form-1 and Mode-2 Form-2, CD-I, Video-CD (MPEG-1), CD-Text CD (write): CD-DA, CD-ROM Mode-1, CD-ROM/XA Mode-2 Form-1 and Mode-2, CD-i, Video-CD, CD-Text	CD: CD-DA, CD-ROM Mode-1, CD-ROM XA Mode-2 Form-1 and Form-2, CD-I Ready, Video-CD(MPEG-1), Karaoke-CD, PhotoCD (Multi-Session), Enhance CD, CD extra, I-Trax CD and UDF
Loading mechanism	Load: Manual load	Manual load/DC brushless motor system
Power Requirement	Max. 1300mA	Max. 1200mA
Input Voltage	5 V +/- 5% (Operating)	5 V +/- 5% (Operating)

#### 8X DVD Dual Interface

Item	Specification
Vendor and model name	PHILIPS SDVD8441
Performance specification	

Item	Specification
Transfer rate (KB/sec.)	Sustained: DVD:10.9Mbytes/sec. (Typ) CD: 3650Kbytes/sec. (Typ)
Access time (typical)	DVD: Random Access: 130 ms DVD: Full Stroke: 240ms CD: Random Access:130ms CD: Full Stroke:240ms
Buffer memory	2MB
Interface	ATA/ATAPI-5
Applicable disc format	DVD (read): DVD-ROM 5,9,10,18, DVD-VIDEO, DVD-AUDIO, DVD-R, DVD-R 3.95G, DVD-R MULTI BORDER, DVD-RW, DVD+R, DVD+R DL, DVD+R MULTI-SESSION, DVD+RW CD (read): CD-DA, CD-ROM Mode-1, CD-ROM/XA Mode-2 Form-1 Form-2, CD-I, CD-I Bridge, Video-CD(MPEG-1), Karaoke CD, Photo-CD, Enhanced CD, CD Plus, CD Extra, i-trax CD, CD-Text, CD-R, and CD-RW DVD (write): DVD Data & Video CD (write): CD-DA, CD-ROM Mode-1, CD-ROM/XA Mode-2 Form-1 and Mode-2 Form-2, CD-i, Video-CD, CD-Text
Loading mechanism	Load: manual load
Power consumption	Max. 1500 mA
Input voltage	5V +/- 5% (operating)

### 8X Super Multi Interface

Item	Specification		
Vendor and model name	Liteon SSM 8515S	Pioneer DVR-K06RS	Philip SDVD-8821
Performance Specification			
Transfer rate read (KB/sec.)	Sustained: • DVD: 10.00Mbytes/sec. • CD: 3500kbytes/sec.	Sustained: • DVD: 10.80Mbytes/sec. • CD: 3600kbytes/sec.	Sustained: • DVD: 10.90Mbytes/sec. • CD: 3650kbytes/sec.
Access time / Seek time	• DVD: random access 130ms • DVD: full stroke 250ms • CD: random access 110ms • CD: full stroke 220ms	• Access time: DVD 160 msec; CD 150 msec. • Random seek time: DVD 150 msec; CD 140 msec. • Full stroke seek time: DVD 300 msec; CD 290 msec.	• Random access: DVD 130ms; CD 130ms • Full stroke: DVD 200ms; CD 240ms
Buffer memory	2MB	2MB	2MB
Interface	compliant to ATA/ATAPI-6, MMC-4 and SFF8090 Ver5	compliant to SFF8020, SFF8090	compliant to ATA/ATA-5

Item	Specification		
Applicable disc format	CD-DA, CD-ROM Mode-1, CD-ROM/XA Mode-2 Form-1 and Mode-2 Form-2, CD-I, Video-CD (MPEG-1), CD-Text, PhotoCD, Enhance CD, CD extra, I-Trax CD and UDF DVD-ROM, DVD-Video, DVD-Audio, DVD-R single/multi border, DVD+R single/multi session, DVD-RW, DVD+RW, DVD-RAM	KODAK Photo CD single and multi-session, CD Extra (CD PLUS), Video CD, CD text data (read/write), CD-R (read/write), DVD-ROM, DVD-R (read/write), DVD-R DL (read/write), DVD-RW (read/write), DVD+RW (read/write), DVD+R (read/write), DVD+R DL (read/write), DVD+RW (read/write), DVD+RW high speed (read/write), DVD-RAM (read/write)	<ul style="list-style-type: none"> <li>• DVD read: DVD-5, DVD-9, DVD-10, DVD-18, DVD-Video, DVD-Audio, SACD (Hybrid), DVD-R, DVD-R DL, DVD-R 3.95GB, DVD-R Authoring, DVD-R multi-border, DVD-RW, DVD+R, DVD+R DL, DVD+R Multi-session, DVD+RW, DVD-RAM V1.0, DVD-RAM V2.1; CD read: CD-DA, CD-ROM Mode-1, CD-ROM/XA Mode-2 Form-1 and Mode-2 Form-2, CD-i, CD-i Bridge, Video-CD (MPEG-1), Karaoke CD, Photo-CD, Enhanced CD, CD Plus, CD Extra, i-trax CD, CD-Text, CD-R, CD-RW</li> <li>• DVD write: DVD Data, DVD-video; CD write: CD-DA, CD-ROM Mode-1, CD-ROM/XA Mode-2 Form-1 and Mode-2 Form-2, CD-i, Video-CD, CD-text</li> </ul>
Loading mechanism	Load: manual load/DC brushless motor system	N/A	N/A
Power requirement	Max. 1500mA	Max. 1800mA	Max. 1300mA
Input voltage	+5V +/- 5% (operating)	+5V +/- 5% (operating) +5V +/- 8% (start-up)	+5V +/- 5% (operating)

## System Utilities

### BIOS Setup Utility

The BIOS Setup Utility is a hardware configuration program built into your computer's BIOS (Basic Input/Output System).

Your computer is already properly configured and optimized, and you do not need to run this utility. However, if you encounter configuration problems, you may need to run Setup. Please also refer to Chapter 4 Troubleshooting when problem arises.

To activate the BIOS Utility, press **m** during POST (when "Press <F2> to enter Setup" message is prompted on the bottom of screen).

The setup screen displays BIOS as follows: Navigating the BIOS Utility

Function	Item
Information	Display the system informations
Main	Allows the user to specify standard IBM PC AT system parameters
Advanced	Provides advanced settings of the system
Security	Provides security settings of the system
Boot	Allows the user to specify the boot options
Exit	Allows the user to save CMOS setting and exit Setup

During setup, all Fn function keys and power saving functions are disabled.

There are five menu options: Main, Advanced, Security, Boot and Exit.

Follow these instructions:

- To choose a menu, use the cursor left/right keys (zx).
- To choose a parameter, use the cursor up/down keys ( wy).
- To change the value of a parameter, press p or q.
- Press ^ while you are in any of the menu options to go to the Exit menu.
- In any menu, you can load default settings by pressing t. You can also press u to save any changes made and exit the BIOS Setup Utility.

**NOTE:** You can change the value of a parameter if it is enclosed in square brackets. Navigation keys for a particular menu are shown on the bottom of the screen. Help for parameters are found in the Item Specific Help part of the screen. Read this carefully when making changes to parameter values.

# Information

PhoenixBIOS Setup Utility	
Info.	Main Security Boot Exit
CPU Type:	AMD Turion(tm) 64 Mobile Technology ML-36
CPU Speed	2.00GHz
IDE1 Model Name:	WDC WD1200UE-22KVT0-(PM)
IDE1 Serial Number:	WD-WXE406360816
System BIOS Version:	v1.00
VGA BIOS Version:	5.51.28.45.00
KBC Version:	08.10
Serial Number:	914Q901051G6310008C2000
Asset Tag Number:	None
Product Name:	Aspire 9300
Manufacturer Name:	Acer
UUID:	2fb91de0-1d5f-11d7-8837-8a090087febe

F1 Help	↑↓ Select Item	F5/F6 Change Values	F9 Setup Defaults
Esc Exit	←→ Select Menu	Enter Select ▶ Sub-Menu	F10 Save and Exit

Parameter	Description
CPU Type	This item will show the CPU information of the system.
CPU Speed	This item will show the CPU clock speed.
IDE1 Model Name	This item will show the Model name of HDD installed on Primary IDE master. The hard disk model name is automatically detected by the system. If there is no hard disk present or unknown type, "None" should be shown on this field
IDE1 Serial Number	This item will show the Serial number of HDD installed on Primary IDE master. If no Hard disk or other devices are installed on Primary IDE master, then it will display a blank line
System BIOS Version	This field reports the BIOS version of system
VGA BIOS Version	This field reports the VGA version of the system
KBC Version	This field reports the keyboard controller version of the system
Serial Number	This item will show the Serial number of system.
Asset Tag Number	This item will show the Asset Tag number of the system.
Product Name	This field will show product name.
Manufacturer Name	This field will show manufacturer name.
UUID	This will be visible only when there is an internal LAN device present.

# Main

This menu provides you the information of the system.

PhoenixBIOS Setup Utility				
Info.	Main	Security	Boot	Exit
<p>System Time: [11:59:38 ]</p> <p>System Date: [01/16/2006]</p> <p>System Memory: 640 KB</p> <p>Extended Memory: 254 KB</p> <p>Video Memory 128 MB</p> <p>Quiet Boot: [Enabled]</p> <p>Power on Display: [Auto ]</p> <p>Network boot [Enabled]</p> <p>F12 Boot Menu: [Disabled]</p> <p>D2D Recovery: [Enabled]</p>		<p>Item Specific Help</p> <p>&lt;Tab&gt;, &lt;Shift-Tab&gt;, or &lt;Enter&gt; selects field.</p>		
F1 Help	↑↓ Select Item	F5/F6 Change Values	F9 Setup Defaults	
Esc Exit	←→ Select Menu	Enter Select	▶ Sub-Menu	F10 Save and Exit

Parameter	Description
System Time / System Date	The hours are displayed with 24 hours format. The values set in these two fields take effect immediately.
System Memory	This field reports the memory size of system base memory. The size is fixed to 640KB.
Extended Memory	This field reports the memory size of the extended memory in the system. Extended Memory size = Total memory size - 1 MB
Video Memory	VGA Memory size = 128MB
Quiet Boot	Customer Logo display will be shown during POST when it is selected.
Power on display	<b>Auto:</b> During power on process, the system will detect if any display device is connected on external video port. If any external display device is connected, the power on display will be in CRT (or projector) only mode. Otherwise it will be in LCD only mode. <b>Both:</b> Simultaneously enable both the integrated LCD screen and the system's external video port (for an external CRT or projector).
Network boot	When this is selected, Boot from LAN feature is enabled. When this is not selected, Boot from LAN feature is then disabled.

---

Parameter	Description
F12 Boot Menu	When this is selected, users can modify device boot priority by pressing F12 key during POST. When this is not selected, device boot priority will not be adjustable during POST.
D2D Recovery	Allow user to enable/disable the Disk-to-Disk recovery



# Security

The Security screen contains parameters that help safeguard and protect your computer from unauthorized use.

PhoenixBIOS Setup Utility				
Info.	Main	Security	Boot	Exit
Supervisor Password Is:		Clear	Item Specific Help  Supervisor Password controls accesses of the setup utility.	
User Password Is:		Clear		
HDD Password		Clear		
Set Supervisor Password		[Enter]		
Set User Password		[Enter]		
Set HDD Password		[Enter]		
Password on Boot:		[Disabled]		
F1 Help	↑ ↓ Select Item	F5/F6 Change Values	F9 Setup Defaults	
Esc Exit	← → Select Menu	Enter Select	▶ Sub-Menu F10 Save and Exit	

The table below describes the parameters in this screen. Settings in **boldface** are the default and suggested parameter settings.

Parameter	Description	Option
Supervisor Password Is	N/A	N/A
User Password Is	N/A	N/A
HDD Password Is	N/A	N/A
Set Supervisor Password	Press Enter to set the administrator password. When set, this password protects the BIOS Setup Utility from unauthorized access. [Set]: System password is set [Clear]: System password is not set	Length -- No more than 8 characters Characters -- 0-9, A-Z (not case sensitive)
Set User Password		

Parameter	Description	Option
Set HDD Password	When shown as [Locked], the hard drive password currently can not be changed or disabled. To change or disable it, turn off the system and enter Setup immediately after turning it back on. Press [Enter] to input change, or disable hard drive password.	<b>Enter</b>
Password on boot	Defines whether a password is required or not while the events defined in this group happened. The following sub-options are all requires the Supervisor password for changes and should be grayed out if the user password was used to enter setup. Allows the user to specify whether or not a password is required to boot.	<b>Disabled</b> Enabled

### ***Set Supervisor/User Password***

If password on boot is required, the password must be set otherwise it cannot be enabled.

The formats of the password are as follows:

Length        No more than 8 characters

Characters    0-9,A-Z (not case sensitive)

While these fields are highlighted and press “Enter”, a window similar to the following is shown:

Set SupervisorPassword		
Enter New Password	[	]
Confirm New Password	[	]

If there is an old password then setup will prompt with the following window instead and a current password will be required to be entered at first:

Set Supervisor Password		
Enter current password	[	]
Enter New Password	[	]
Confirm New Password	[	]

---

User can now type password in field “Enter New Password”, and re-enter password in field “Confirm New Password” for verification.

If the verification is OK:

The password setting is complete after user presses enter.

Setup Notice

Changes have been saved.

[ continue]

If the current password entered does not match the actual current password:

Setup Warning

Invalid password

Re-enter Password

[ continue]

If the new password and confirm new password strings do not match:

Setup Warning

Password do not match

Re-enter Password

# Boot

This menu allows the user to decide the order of boot devices to load the operating system. Bootable devices includes the distette drive in module bay, the onboard hard disk drive and the CD-ROM in module bay and onboard LAN device.

PhoenixBIOS Setup Utility				
Info.	Main	Security	Boot	Exit
<b>Boot priority order:</b> 1: IDE HDD: WDC WD1200UE-22KVT0-(PM) 2: IDE CDROM: PHILIPS DVD-RAM SDVD8821 3: PCI LAN: NVIDIA Noot Agent 232.0529 4: USB HDD: 5: USB CDROM: 6: USB FDC: 7: USB KEY:			<b>Item Specific Help</b>  Use <↑> or <↓> to select a device, then press <F6> to move it up the list, or <F5> to move it down the list.  Press <Esc> to escape the menu.	
F1 Help	↑↓ Select Item	F5/F6 Change Values	F9 Setup Defaults	
Esc Exit	←→ Select Menu	Enter Select	▶ Sub-Menu	F10 Save and Exit

Parameter	Description
Boot priority order	Keys used to view or configure devices: Up and Down arrows select a device. <+> and <-> movew the device up or down. <f> and <r> specifies the device fixed or removable. > <x> exclude or include the device to boot. <Shift +1> enables or disables a device. <1-4> Loads default boot sequence.

# Exit

PhoenixBIOS Setup Utility				
Info.	Main	Security	Boot	Exit
Exit Saving Changes Exit Discarding Changes Load Setup Defaults Discard Changes Save Changes				Item Specific Help  Exit System Setup and save your changes to CMOS.
F1 Help	↑↓ Select Item	F5/F6 Change Values	F9 Setup Defaults	
Esc Exit	←→ Select Menu	Enter Select	▶ Sub-Menu	F10 Save and Exit

The table below describes the parameters in this screen.

Parameter	Description
Exit Saving Changes	Exit System Setup and save your changes to CMOS
Exit Discarding Changes	Exit utility without saving Setup data to CMOS
Load Setup Default	Load default values for all SETUP items
Discard Changes	Load previous values from CMOS for all SETUP items
Save Changes	Save Setup Data to CMOS

# *Machine Disassembly and Replacement*

---

## *General Information*

This chapter contains step-by-step procedures on how to disassemble the notebook for maintenance and troubleshooting.

To disassemble the computer, you need the tools below:

- Wrist ground strap and conductive mat for preventing electrostatic discharge
- Small Philips screw driver
- Flat head screw driver
- Hexagonal driver
- Tweezers

**NOTE:** The screws for the different components vary in size. During the disassembly process, group the screws with the corresponding components to avoid mismatch when putting back the components. When you remove the stripe cover, please be careful not to scrape the cover.

## *Before You Begin*

Before proceeding with the disassembly procedure, you have to make sure that:

1. The system and all peripherals are powered off.
2. The AC adaptor and all power and signal cables from the system are unplugged.
3. The battery pack is removed.

**NOTE:** There are several types of screws used to secure the main unit. The screws vary in length. Please refer to the screws table after the flowchart. Group the same type of screws together during service disassembling. Please also remember the screw location for each screw type. If you fasten the screws on the wrong location, the long screws may cause irrecoverable damage to the main board.

# Disassembly Procedure Flowchart

The flowchart gives you a graphic representation on the entire disassembly and reassembly and instructs you how to remove the components.

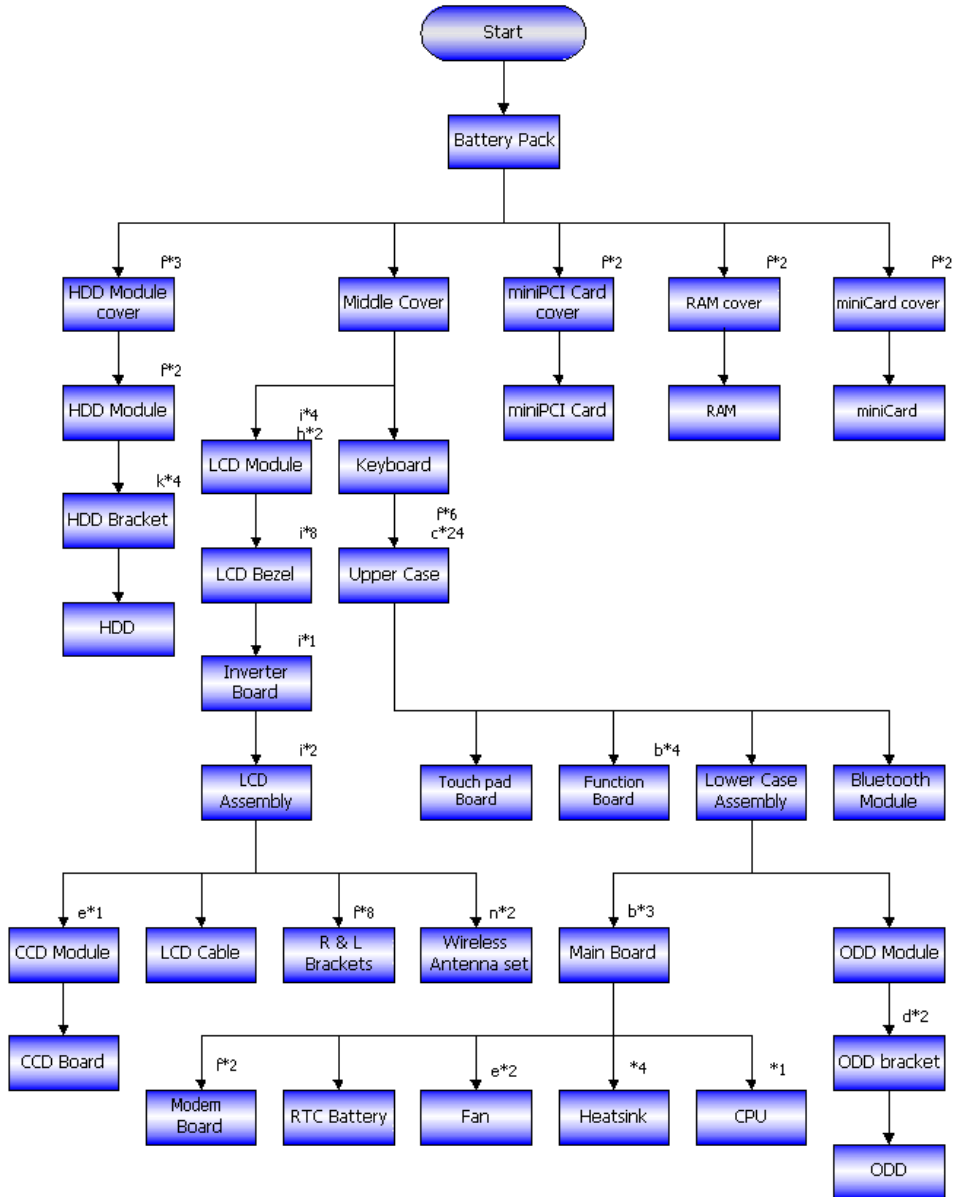

## Screws List

No.	Description	Part No.
a	SCW HEX NYL I#R-40/O#4-40 L5.5	34.00015.081
b	SCREW MACH WAFER M2*L4 NI	86.T39V1.002
c	SCRW M2.5*6 ~ L-CASE + U-CASE	86.00D28.330
d	SCRW M2*L3	86.00D29.620
e	SCRW M2.5*5 WAFER B-ZN ROHS	86.00D47.630
f	SCREW M2*L3 NYLOK CR 3+	86.00E25.723

---

Screws List

No.	Description	Part No.
g	SCREW M2*L3 NON-NYLOK CR3+	86.00E31.723
h	SCREW M2.5*L6 NYLOK CR3+	86.00E33.736
i	SCREW M2.5*L8 NYLOK CR3+	86.00E34.738
j	SCREW M2*L8 NI NON-NYLOK	86.00E35.228
k	SCREW M3x4(86.9A524.4R0)	86.9A524.4R0
l	SCRW M2*4 WAFER NI	86.9A552.4R0
m	SCREW NI M2*6L	86.9A552.6R0
n	SCRW M2.5*L3(NON NYLOK)	86.9A523.3R0



## ***Disassembly Procedure***

### ***Removing the Battery Pack***

1. Unlock the battery pack.
2. Slide the battery latch, hold it then remove the battery.



### ***Removing the HDD Module***

1. Release the three screws fastening the HDD module cover.
2. Detach the HDD module cover.
3. Release the two screws holding the HDD module then pull the HDD module as arrow indicates and remove the HDD module.

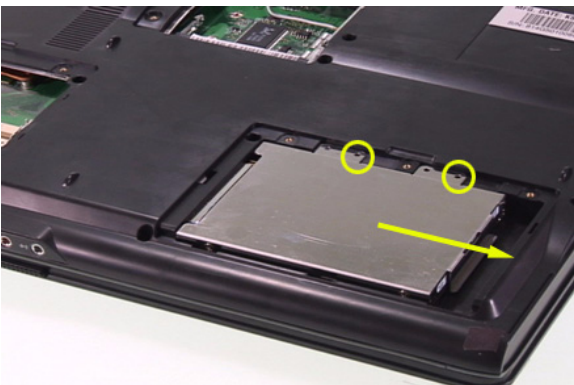

## Removing the Wireless LAN Card and the RAM Modules

1. Release the two screws securing the wireless LAN card cover.
2. Remove that cover.
3. Disconnect the wireless antennae. The black is the main cable and the white is the auxiliary one.
4. Press the left and the right latches to pop up the wireless LAN card.

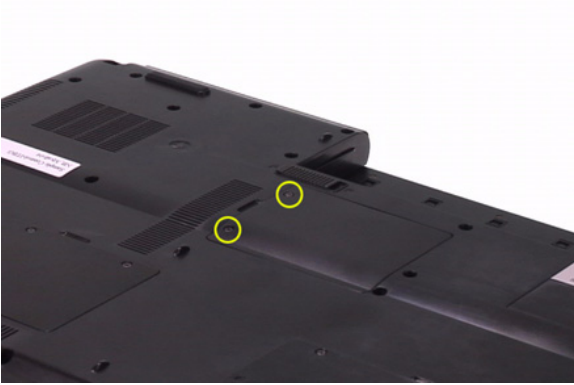

5. Release the two screws securing the RAM cover and remove the RAM cover.
6. Press the left and right latches to pop up the RAM module.
7. Repeat the anterior step to remove other RAM module.

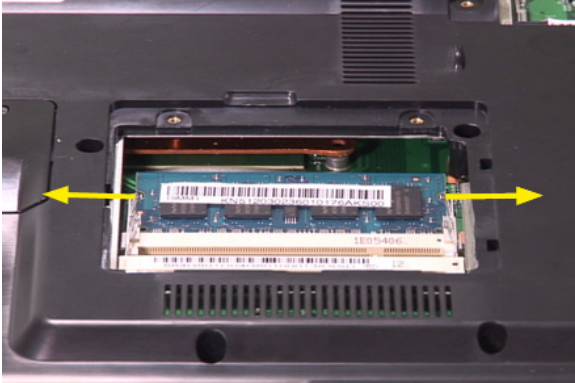



## Removing the Keyboard

1. Open the notebook as shown.
2. Remove the middle cover. Though it is combined tightly, detach it from the main unit carefully. Do not pull it abruptly.
3. There are four latches securing the keyboard.
4. Push those latches by the screw driver as shown and the keyboard will pop up a little.
5. Remove the keyboard and reverse it.
6. Carefully pull the keyboard FFC lock, then disconnect the keyboard FFC.

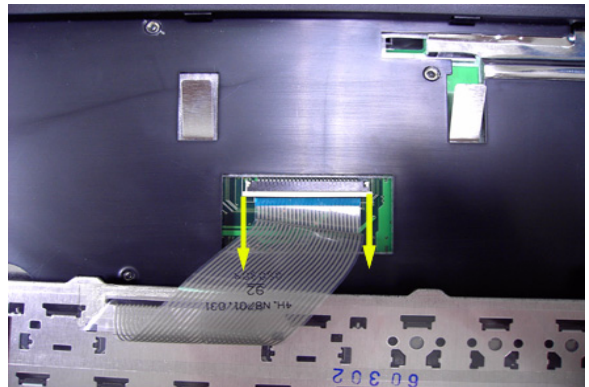

## ***Separating the LCD Module and Main Unit***

1. Pull carefully and disconnect the LCD cable.
2. Tear off the tape securing the wireless antennae and pull out the wireless antennae.
3. Release the two screws securing the LCD hinges on the bottom side.
4. Release the two screws fastening the LCD hinges on the rear side.
5. Release the two screws holding the LCD hinges as shown.
6. Then separate the LCD module from the main unit.

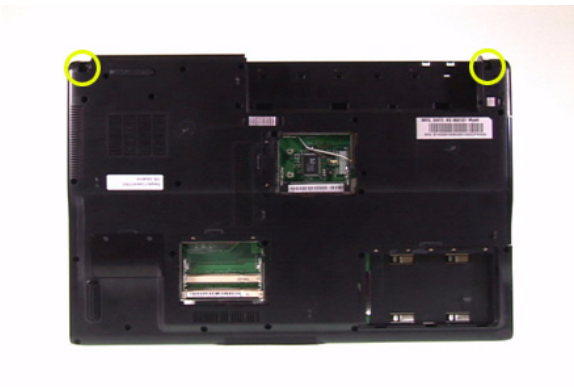
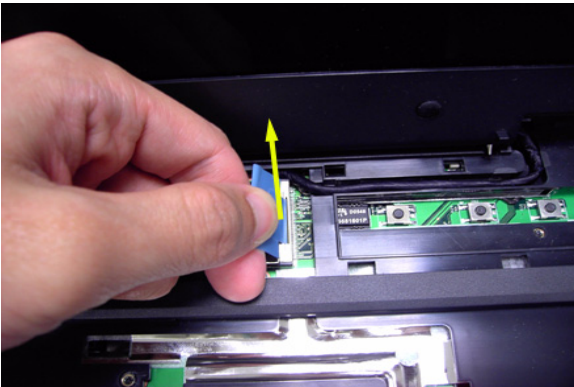

## ***Disassembling the Main Unit***

### **Separating the Upper Case and the Lower Case**

1. Release the connector lock and disconnect the touch pad FFC.
2. Release the connector lock and disconnect the function keyboard FFC.
3. Release the three screws securing the upper case.
4. Release the 27 screws holding the lower case.
5. Lift the upper case carefully and disconnect the lid switch cable.
6. Then separate the upper and the lower case.

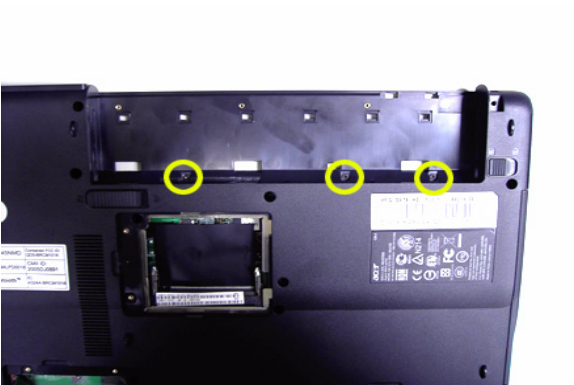
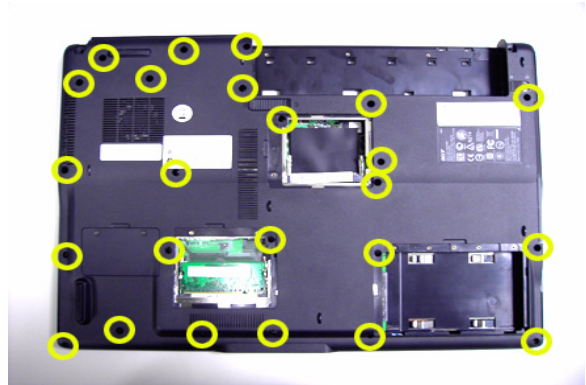
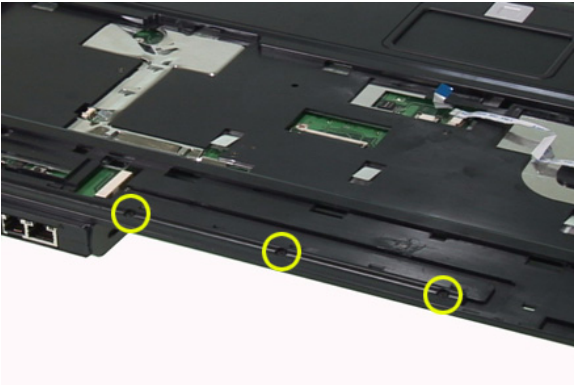
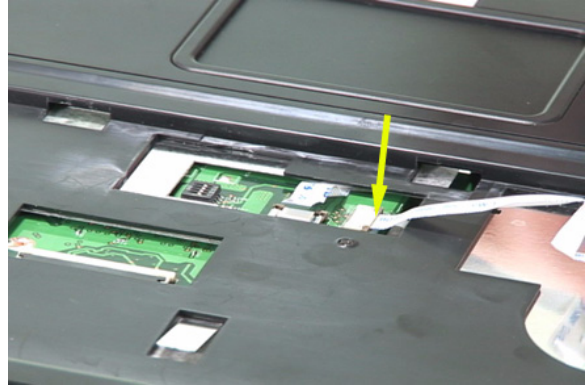
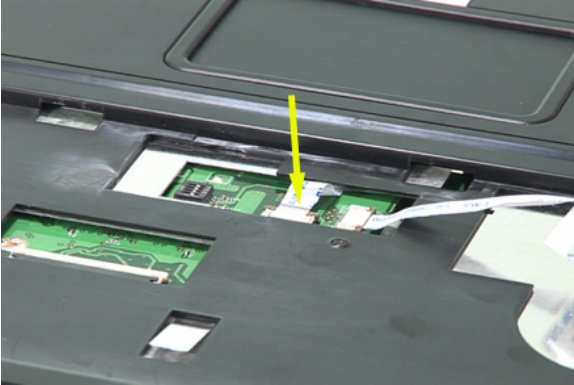





### Removing the Function Keyboard

1. Release the FFC lock and disconnect the function keyboard FFC.
2. Release the four screws holding the function keyboard bracket.
3. Then remove the function keyboard bracket.
4. Carefully disconnect the microphone cable and remove the function keyboard.

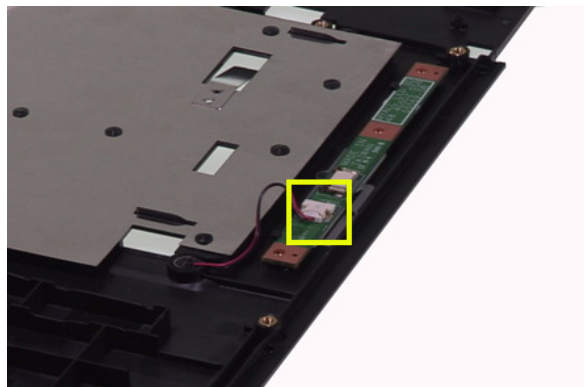
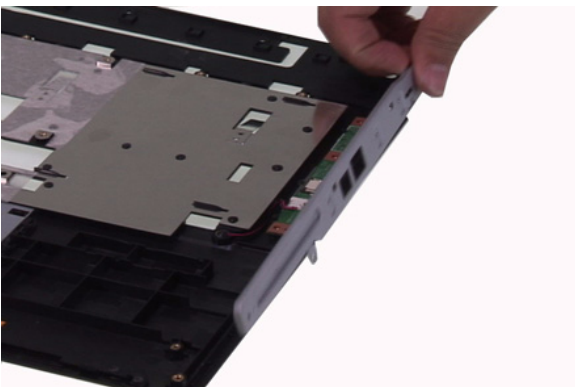
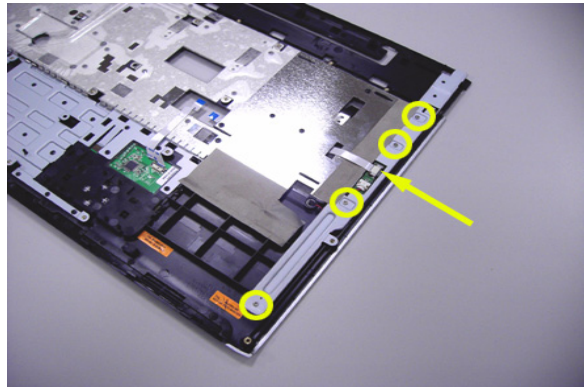
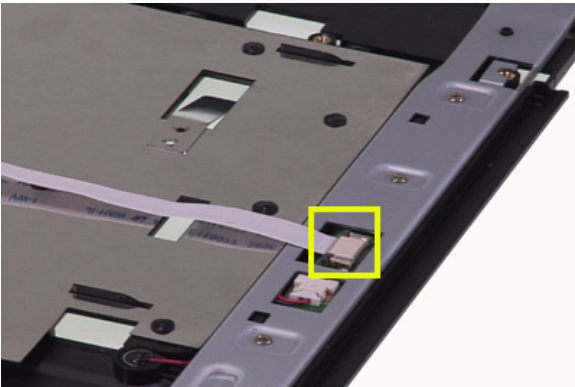

## Removing the Touch Pad Board

1. Carefully release the FFC lock and disconnect the touch pad board FFC.
2. There are 13 latches holding the touch pad bracket.
3. Unlock those latches with a screw driver as shown then detach the touch pad bracket.
4. Detach the touch pad board.

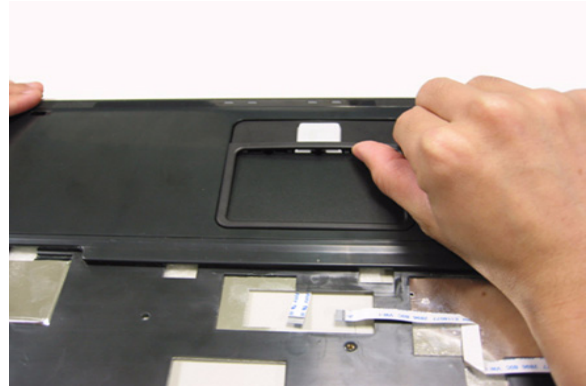
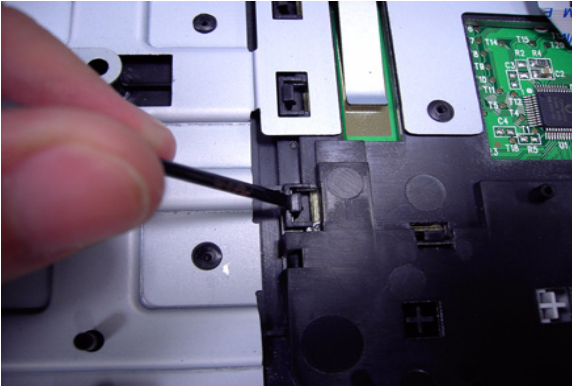
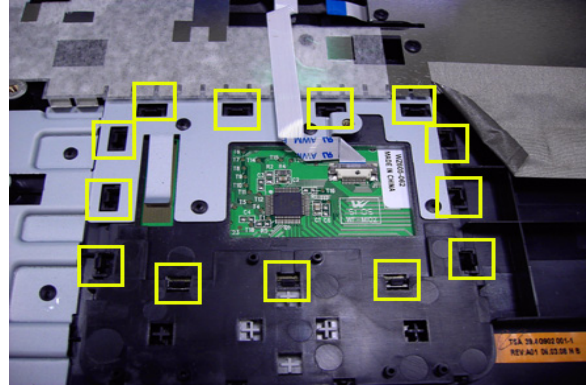
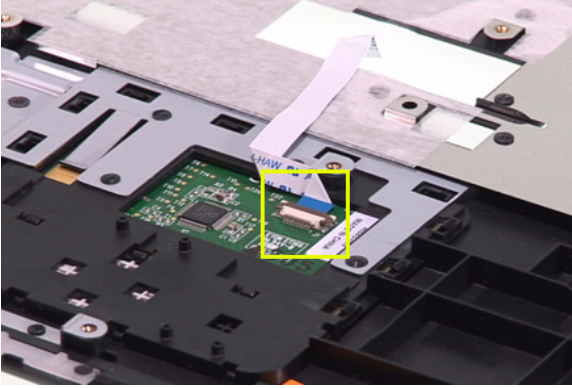



## Removing the ODD Module and Dummy Card

1. Slightly pull the ODD module and remove it.
2. Pull the dummy card from the slot and remove it.

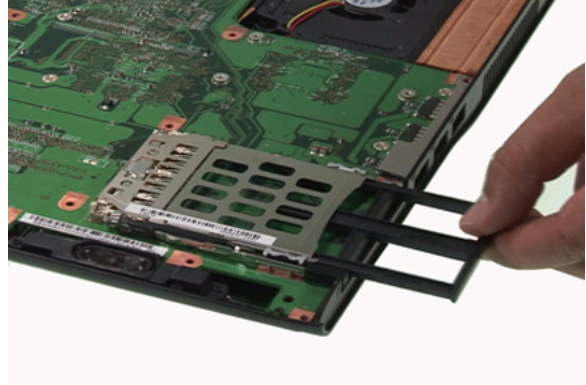
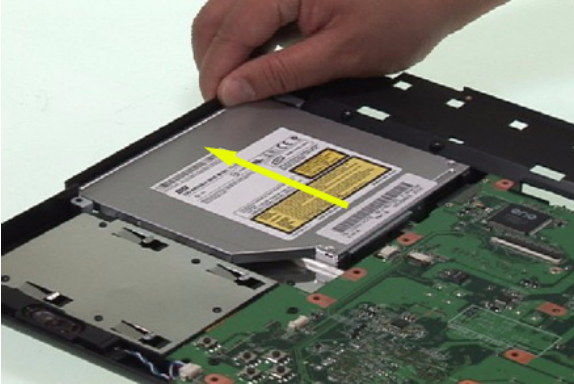

## Removing the Main Board

1. Disconnect the fan cable.
2. Disconnect the speaker cable and Bluetooth module cable.
3. Remove the four screws securing the main board.
4. Then detach the main board from the lower case.

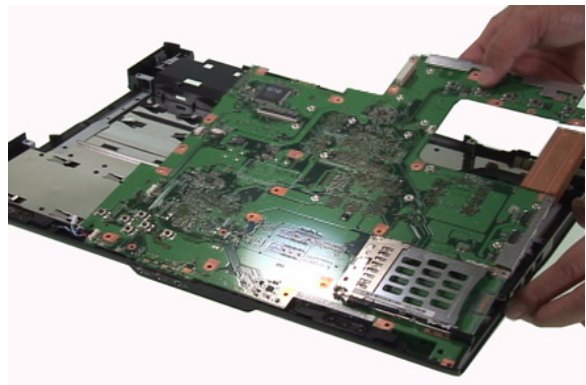
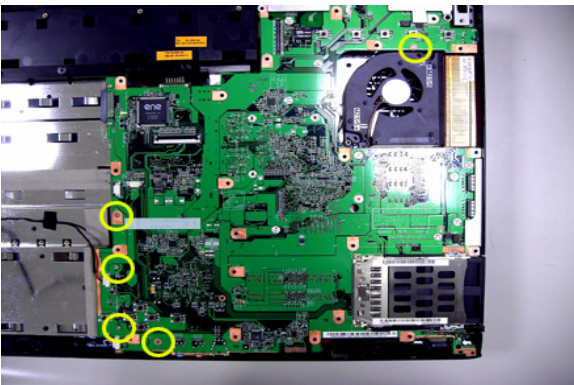
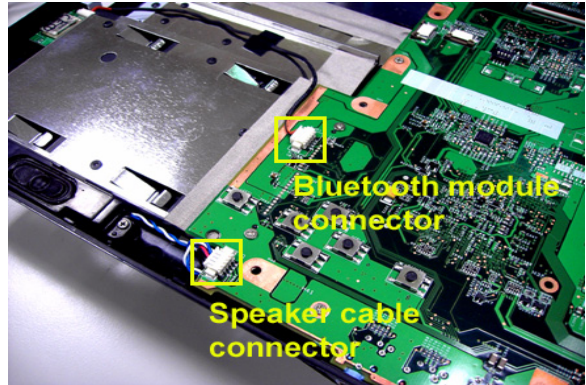
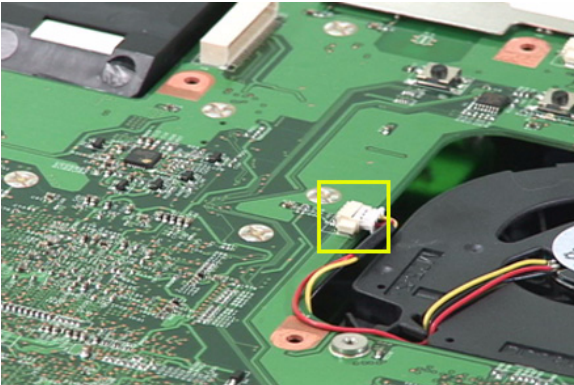

---

### Removing the System Fan

1. Release the two screws holding the heatsink.
2. Remove the heatsink.

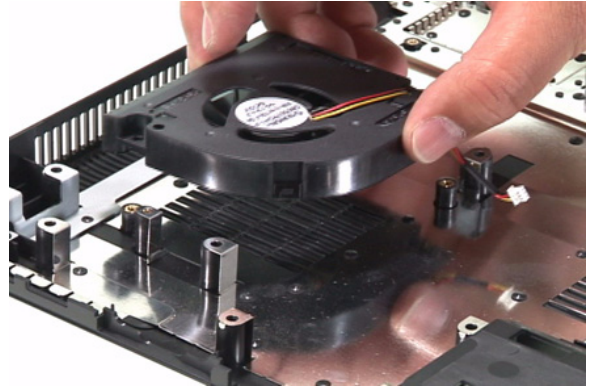
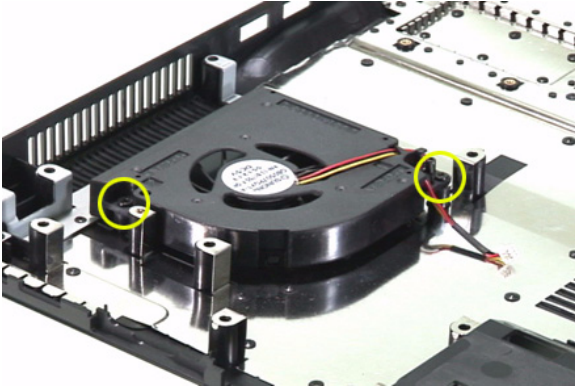

### Removing the Bluetooth Module

1. Detach the bluetooth module from the lower case.
2. Carefully disconnect the bluetooth module cable.

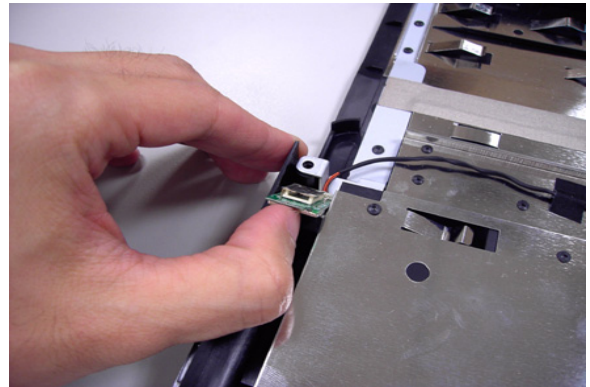
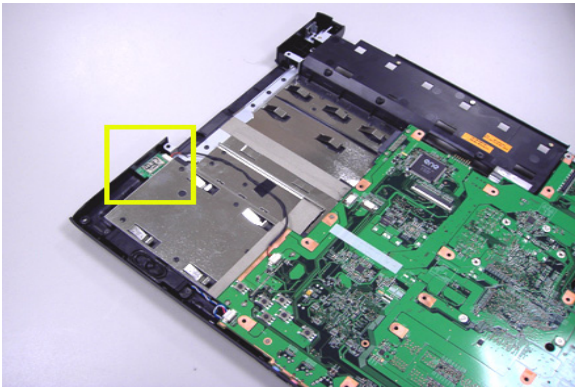



---

## Removing the Speakers

1. Release the four screws securing the left and right speakers.
2. Remove the speakers from the lower case.

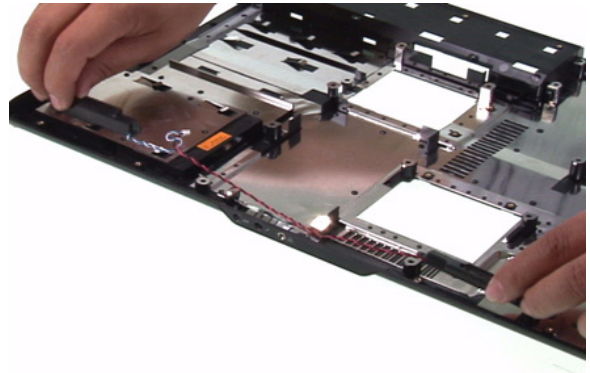
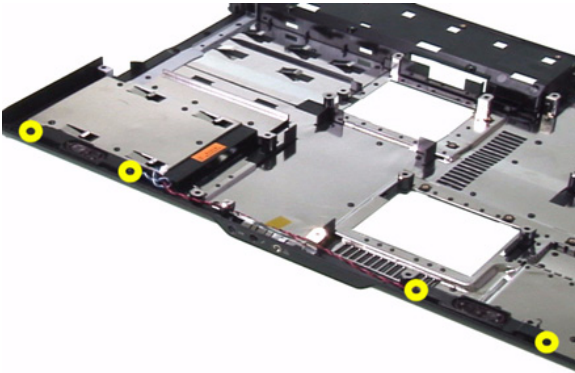

## Removing the MDC Module

1. Carefully disconnect the MDC cable.
2. Release the two screws securing the MDC board then detach the MDC board.
3. Disconnect the MDC board cable.

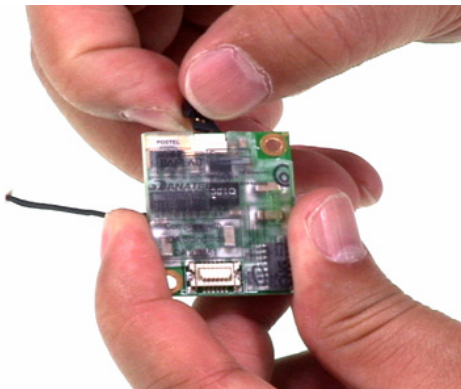
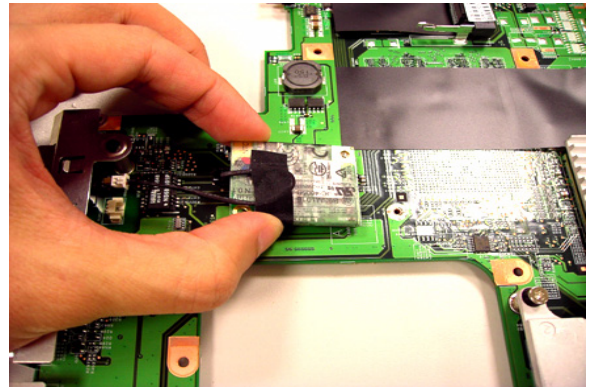
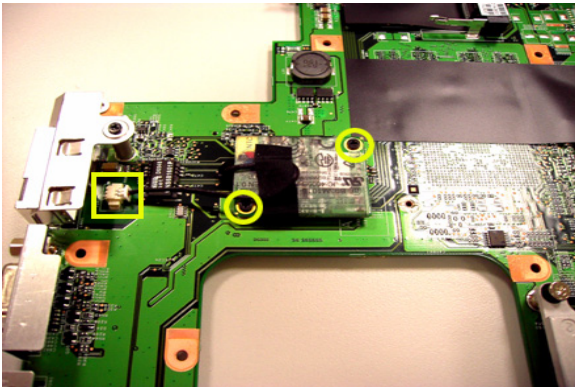

---

## Remove the Heatsink Module

1. Release the five screws securing the heatsink.
2. Remove the heatsink module.

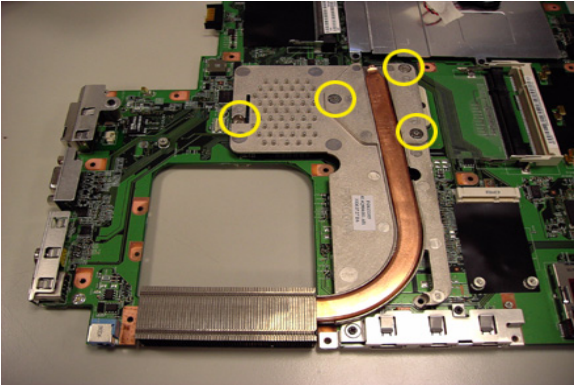

## Removing the CPU

1. Release the screw counter clockwise with a flat screw driver.
2. Detach the CPU from the CPU socket.

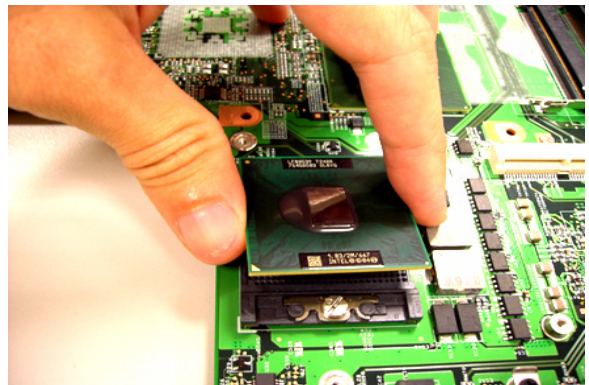
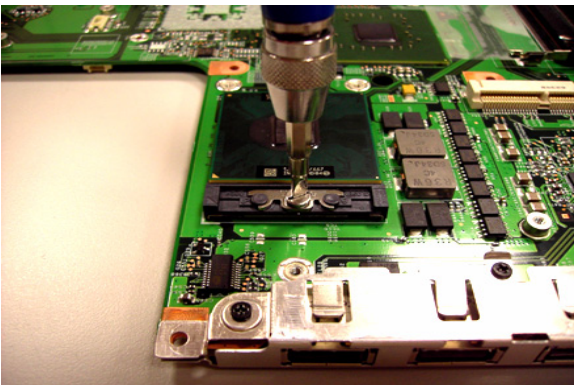

## ***LCD Disassembly***

1. Remove the eight rubber caps on the LCD bezel and release the eight screws securing the LCD bezel.
2. Detach the LCD bezel from the LCD module as shown.
3. Release the screw holding the inverter board.
4. Disconnect the inverter board cables as shown and remove the inverter board.

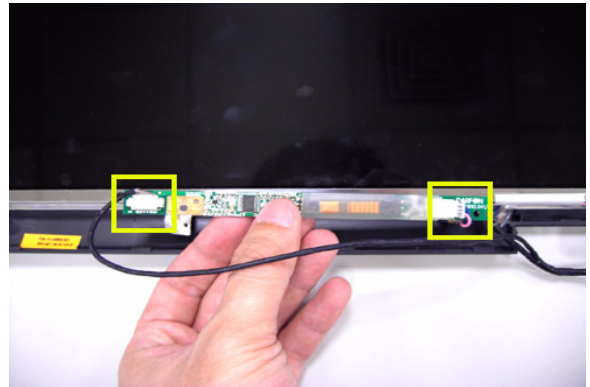



5. Release the four screws securing the LCD panel.
6. Detach the LCD panel carefully and reverse it as shown.
7. Tear off the tapes holding the LCD panel cable carefully then disconnect the LCD panel.
8. Remove the antenna from the LCD cover.

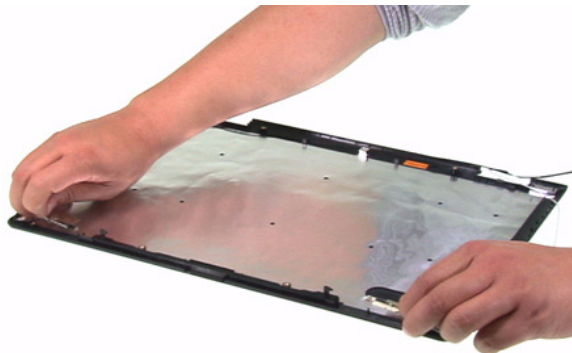
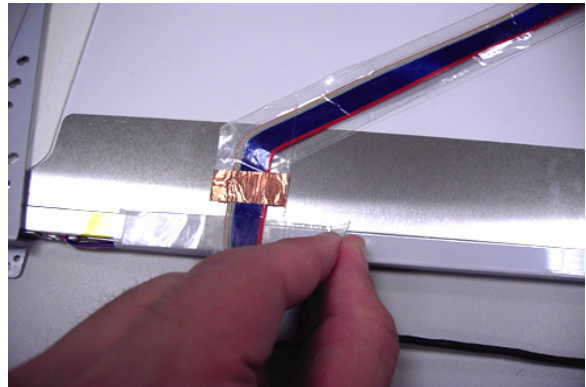
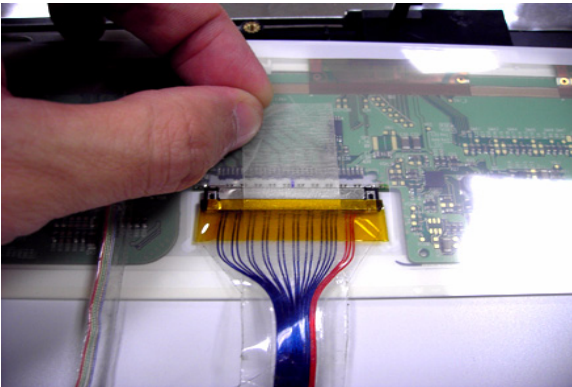
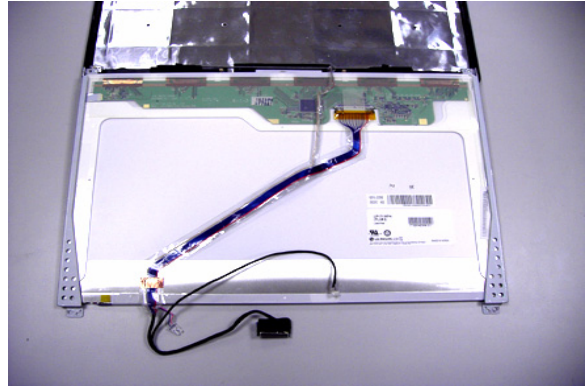
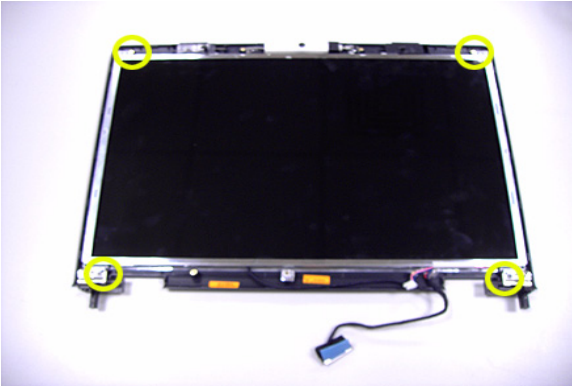

- 
9. Release the four screws securing the left LCD bracket then remove the left LCD bracket.
  10. Repeat the anterior step to remove the right LCD bracket.

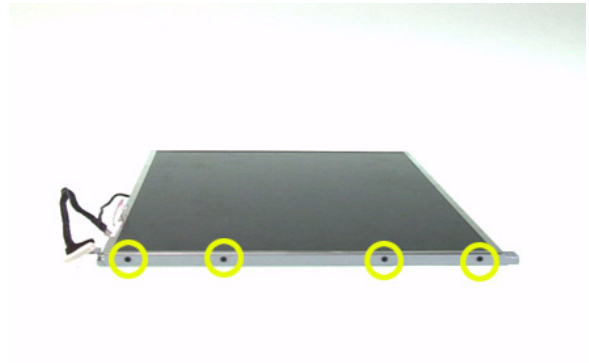
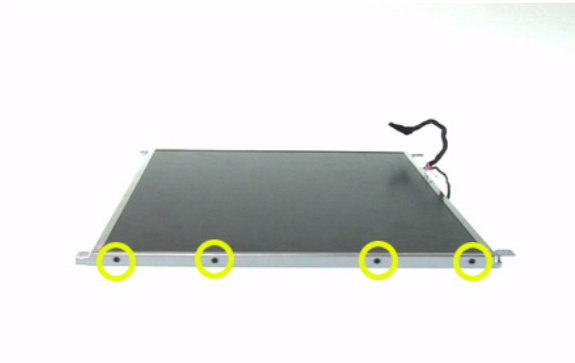

11. Release the screw holding the CCD module and carefully pull the CCD module cable and LCD cable through the latch bar and LCD cover.
12. Remove the CCD module cap.
13. Remove the CCD module ring.
14. Push the CCD module upper case a little bit.
15. Then Separate the lower case from the upper case.
16. Release the two screws holding the CCD module board the detach the CCD module board.

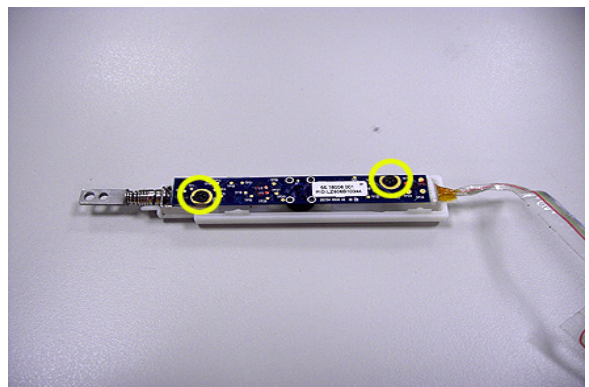
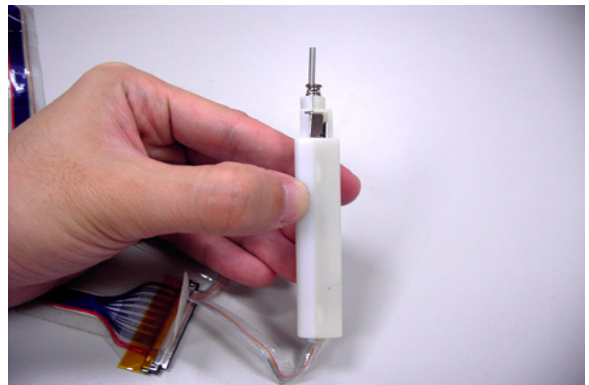
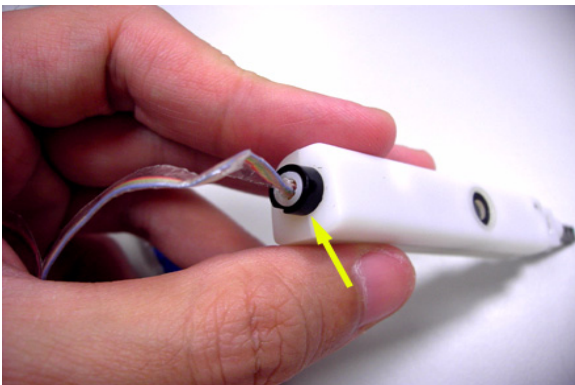
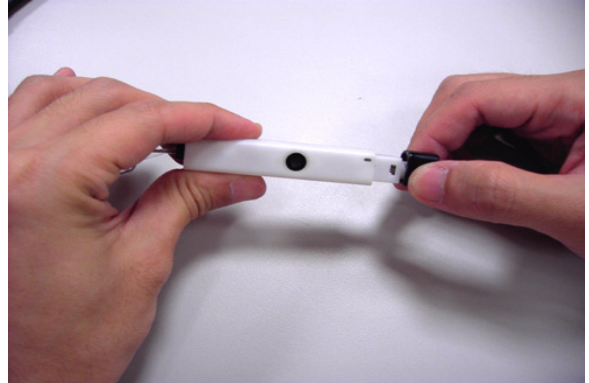
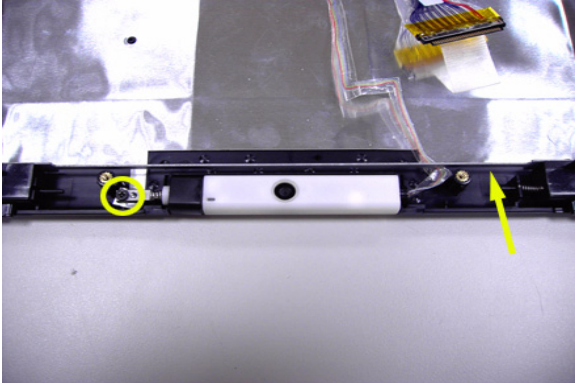





## *Troubleshooting*

---

Please use the following procedures as a guide for computer problems.

**NOTE:** The diagnostic tests are intended to test only Acer products. Non-Acer products, prototype cards, or modified options may occur errors or invalid responses.

1. Obtain the detailed fail symptoms as many as possible.
2. Verify the symptoms by attempting to recreate, running the diagnostic tests or repeating the same operation.
3. Disassemble and assemble the unit without any power sources.
4. If any problem occurs, you can perform visual inspection before you follow this chapter's instructions. You can check the following:
  - Power cords are properly connected and secured;
  - There are no obvious shorts or opens;
  - There are no obviously burned or heated components;
  - All components appear normal.

---

# ***System Check Procedures***

## ***External Diskette Drive Check***

Do the following procedures to isolate the possible effects from a controller, driver, or diskette. A writable, diagnostic diskette is required.

**NOTE:** Make sure that the diskette does not have more than one label attached. Multiple labels may cause damage to the drive or make the drive fail.

1. Boot from the diagnostic diskette and start the diagnostic programs.
2. See if FDD test is passed as the programs run the FDD test.
3. Follow the instructions in the message window.

If errors occur with the internal diskette driver, reconnect the diskette connector on the system board. If the errors still remain:

1. Reconnect the external diskette drive.
2. Replace the external diskette driver.
3. Replace the main board.

## ***External CD-ROM Drive Check***

Do the following procedures to isolate the possible effects from a controller, driver, or CD-ROM.

**NOTE:** Make sure that the CD-ROM does not have any label attached. The label may cause damage to the drive or make the drive fail.

1. Boot from the diagnostic diskette and start the diagnostic programs.
2. See if CD-ROM test is passed when the programs run the CD-ROM test.
3. Follow the instructions in the message window.

If errors occur, reconnect the connector on the system board. If the errors still remain:

1. Reconnect the external CD-ROM drive.
2. Replace the external CD-ROM drive.
3. Replace the main board.

## ***Keyboard or Auxiliary Input Device Check***

Remove the external keyboard if the internal keyboard is under test. If the internal keyboard does not work or an unexpected error appears, make sure that the flexible cable extending from the internal keyboard is correctly connected on the system board. If the keyboard is correctly connected, run the Keyboard test.

If errors occur, do the following procedures in sequence to correct the problems. Do not replace a non-defective FRU.

1. Reconnect the keyboard cable.
2. Replace the keyboard.
3. Replace the main board.

The following auxiliary input devices are supported by this computer.

- ❑ Numeric keypad
- ❑ External keyboard

If any of these devices do not function, reconnect the cable and repeat the anterior procedures.

## ***Memory Check***

Follow the procedures below to correct the memory errors.

1. Boot from the diagnostic diskette and start the diagnostic programs.
2. Go to the diagnostic memory in the test items.
3. Press F2 in the test items.
4. Follow the instructions in the message window.

**NOTE:** Make sure that the DIMM is correctly inserted into the connector. A wrong connection will cause errors.

## ***Power System Check***

To verify the symptoms, power on the computer by using the following power sources separately.

1. Remove the battery pack.
2. Connect the power adaptor and check the power supply.
3. Disconnect the power adaptor and install the battery pack, then check the power supply.

If you think there is a power supply problem, please go to “Check the Power Adaptor” and “Check the Battery Pack” in this chapter.

## ***Check the Power Adaptor***

Unplug the power adaptor cable from the computer and measure the output voltage at the plug of the power adaptor cable. See the illustration and follow the procedures below.

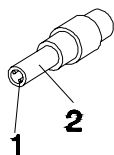

pin 1: +19V to +20.5V  
pin 2: 0V, ground

1. If the voltage is not correct, replace the power adaptor.
2. If the voltage is within the range:
  - (1) Replace the system board.
  - (2) If the problem is still not resolved, see “Undetermined Problems”.
  - (3) If the voltage is not correct, go to the next step.

**NOTE:** An audible noise from the power adaptor does not always indicate a defect.

3. If the power-on indicator does not light up, check the power cord of the power adaptor for continuity and correct installation.
4. If the operational charge does not work, see “Check the Battery Pack”.

---

## ***Check the Battery Pack***

Follow the procedures below to check the battery pack.

From software, this helps to identify the problem is on recharging or discharging.

1. Check the Power Management in Control Panel.
2. Then confirm that the parameters shown in the screen for Current Power Source and Total Battery Power Remaining are correct.
3. Repeat the step 1 and step 2 for both battery and adaptor.

From hardware, this helps to identify whether you should replace the battery pack or not.

1. Power off the system.
2. Remove the battery pack and measure the voltage between terminals one (+) and seven (-). There are seven terminals totally. See the illustration below.

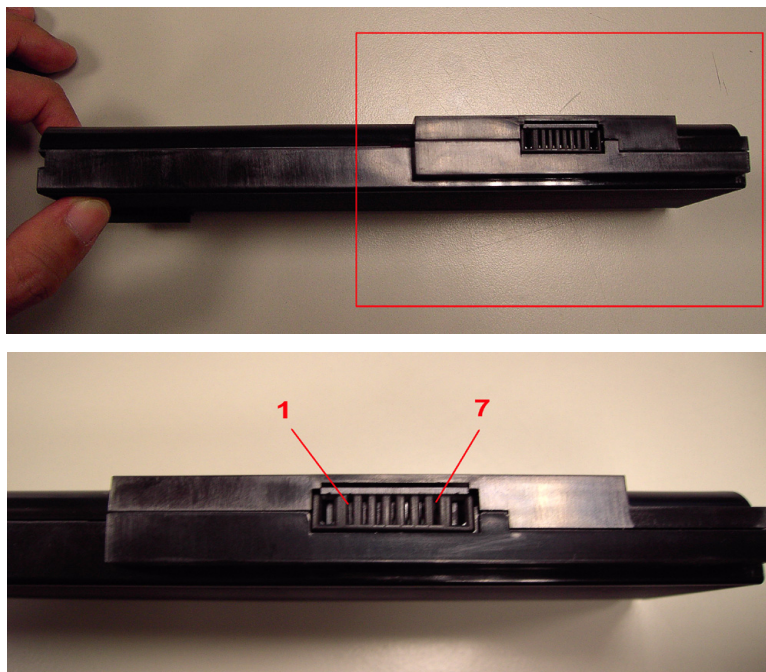

3. If the voltage is still less than 7.5V after recharging, replace the battery.

If the battery status indicator does not light up, remove the battery pack. After the battery pack returns to room temperature, reinstall it to the system.

If the charge indicator does not light up, replace the battery pack. If the charge indicator still does not light up, replace the AC/DC charger board.

## ***Touchpad Check***

If the touchpad does not work, follow the procedures one at a time to correct the problem. Do not replace a non-defective FRU.

1. After rebooting, run Tracking Pad PS2 Mode Driver. For example, run Syn touch driver.
2. Run utility with the PS/2 mouse function and check if the mouse is working.

- 
3. If the PS/2 mouse does not work, then check if the main board to switch board FPC is connected properly.
  4. If the main board to switch board FPC is connected correctly, then check if the FFC on the touch pad PCB is connected properly.
  5. If the FFC on the touch pad PCB is connected correctly, check if LS851 JP1 Pin6 = 5V are pules. If yes, then replace switch board. If not, then go to the next step.
  6. Replace the touch pad PCB.
  7. If the touch pad still does not work, then replace the FPC on Track Pad PCB.

After you use the touchpad, the pointer drifts on the screen for a short time. This self-acting pointer movement will occur when a slight, steady pressure is applied to the touchpad pointer. This symptom is not a hardware problem. No actions are necessary to be taken if the pointer movement stops in a short period of time.

---

## ***Power-On Self-Test (POST) Error Message***

The POST error message index lists the error message and their possible causes.

**NOTE:** Perform the FRU replacement or actions in the sequence shown in Error Message List, if the FRU replacement does not solve the problem, put the original part back in the computer. Do not replace a non-defective FRU.

The error messages are listed in the coming pages to indicate the BIOS signals on the screen and the error symptoms classified by functions. If the symptom is not included on the list, please refer to “Undetermined Problems”.

**NOTE:** Most of the error messages occur during POST. Some of them show information about a hardware device, for example, the size of memory installed. Others may indicate problems with a device, such as the way it has been configured.

**NOTE:** If the system fails after you make changes in the BIOS Setup Utility menus, please reset the computer. Enter Setup and install Setup defaults to correct the errors.

# Index of Error Messages

## Error Message List

Error Messages	FRU/Action in Sequence
Struck Key	See "Keyboard or Auxiliary Input Device Check".
System CMOS checksum bad - Default configuration used	RTC battery Run BIOS Setup Utility to reconfigure system, then reboot system.
Real time clock error	RTC battery Run BIOS Setup Utility to reconfigure system time, then reboot system. Main board
Previous boot incomplete - Default configuration used	"Load Default Settings" in BIOS Setup Utility. RTC battery Main board
Invalid System Configuration Data	"Load Default Settings" in BIOS Setup Utility. Main board
Operating system not found	Enter Setup and see if fixed disk and drive A are properly identified. Diskette drive Hard disk drive Main board
Power-on indicator turns off and LCD is blank.	Power source (battery pack and power adapter.) See "Power System Check". Ensure every connector is connected tightly and correctly. Reconnect the DIMM. Main board.
Power-on indicator turns on and LCD is blank.	Power source (battery pack and power adapter.) See "Power System Check". Reconnect the LCD connector Hard disk drive LCD cable LCD inverter LCD Main board
Power-on indicator turns on and LCD is blank. But you can see POST on an external CRT.	Reconnect the LCD connectors. LCD cable LCD inverter LCD Main board
Power-on indicator turns on and a blinking cursor shown on LCD during POST.	Ensure every connector is connected tightly and correctly. Main board



## Phoenix BIOS Beep Codes

Code	Beeps	POST Routine Description
02h		Verify Real Mode
03h		Disable Non-Maskable Interrupt (NMI)
04h		Get CPU type
06h		Initialize system hardware
07h		Disable shadow and execute code from the ROM.
08h		Initialize chipset with initial POST values
09h		Set IN POST flag
0Ah		Initialize CPU registers
0Bh		Enable CPU cache
0Ch		Initialize caches to initial POST values
0Eh		Initialize I/O component
0Fh		Initialize the local bus IDE
10h		Initialize Power Management
11h		Load alternate registers with initial POST values
12h		Restore CPU control word during warm boot
13h		Initialize PCI Bus Mastering devices
14h		Initialize keyboard controller
16h	1-2-2-3	BIOS ROM checksum
17h		Initialize cache before memory autosize
18h		8254 timer initialization
1Ah		8237 DMA controller initialization
1Ch		Reset Programmable Interrupt Controller
20h	1-3-1-1	Test DRAM refresh
22h	1-3-1-3	Test 8742 Keyboard Controller
24h		Set ES segment register to 4 GB
28h		Autosize DRAM
29h		Initialize POST Memory Manager
2Ah		Clear 215 KB base RAM
2Ch	1-3-4-1	RAM failure on address line xxxx
2Eh	1-3-4-3	RAM failure on data bits xxxx of low byte of memory bus
2Fh		Enable cache before system BIOS shadow
32h		Test CPU bus-clock frequency
33h		Initialize Phoenix Dispatch Manager
36h		Warm start shut down
38h		Shadow system BIOS ROM

Code	Beeps	POST Routine Description
3Ah		Autosize cache
3Ch		Advanced configuration of chipset registers
3Dh		Load alternate registers with CMOS values
41h		Initialize extended memory for RomPilot.
42h		Initialize interrupt vectors
45h		POST device initialization
46h	2-1-2-3	Check ROM copyright notice
47h		Initialize I20 support
48h		Check video configuration against CMOS
49h		Initialize PCI bus and devices
4Ah		Initialize all video adapters in system
4Bh		QuietBoot start (optional)
4Ch		Shadow video BIOS ROM
4Eh		Display BIOS copyright notice
50h		Display CPU type and speed
51h		Initialize EISA board
52h		Test keyboard
54h		Set key click if enabled
55h		Enable USB devices
58h	2-2-3-1	Test for unexpected interrupts
59h		Initialize POST display service
5Ah		Display prompt "Press F2 to enter SETUP"
5Bh		Disable CPU cache
5Ch		Test RAM between 512 and 640 KB
60h		Test extended memory
62h		Test extended memory address lines
64h		Jump to User Patch1
66h		Configure advanced cache registers
67h		Initialize Multi Processor APIC
68h		Enable external and CPU caches
69h		Setup System Management Mode (SMM) area
6Ah		Display external L2 cache size
6Bh		Load custom defaults (optional)
6Ch		Display shadow-area message
6Eh		Display possible high address for UMB recovery
70h		Display error messages
72h		Check for configuration errors
76h		Check for keyboard errors

Code	Beeps	POST Routine Description
7Ch		Set up hardware interrupt vectors
7Eh		Initialize coprocessor if present
80h		Disable onboard Super I/O ports and IRQs
81h		Late POST device initialization
82h		Detect and install external RS232 ports
83h		Configure non-MCD IDE controllers
84h		Detect and install external parallel ports
85h		Initialize PC-compatible PnP ISA devices
86h		Re-initialize onboard I/O ports
87h		Configure Motherboard Configurable Devices (optional)
88h		Initialize BIOS Data Area
89h		Enable Non-Maskable Interrupts (NMIs)
8Ah		Initialize Extended BIOS Data Area
8Bh		Test and initialize PS/2 mouse
8Ch		Initialize floppy controller
8Fh		Determine number of ATA drives (optional)
90h		Initialize hard-disk controllers
91h		Initialize local-bus hard-disk controllers
92h		Jump to UserPatch2
93h		Build MPTABLE for multi-processor boards
95h		Install CD ROM for boot
96h		Clear huge ES segment register
97h		Fixup Multi Processor table
98h	1-2	Search for option ROMs. One long, two short beeps on checksum failure.
99h		Check for SMART drive (optional)
9Ah		Shadow option ROMs
9Ch		Set up Power Management
9Dh		Initialize security engine (optional)
9Eh		Enable hardware interrupts
9Fh		Determine number of ATA and SCSI drives
A0h		Set time of day
A2h		Check key lock
A4h		Initialize Typematic rate
A8h		Erase F2 prompt
AAh		Scan for F2 key stroke
ACh		Enter SETUP
A Eh		Clear Boot flag
B0h		Check for errors

Code	Beeps	POST Routine Description
B1h		Inform RomPilot about the end of POST.
B2h		POST done- prepare to boot operating system
B4h	1	One short beep before boot
B5h		Terminate QuietBoot (optional)
B6h		Check password (optional)
B7h		Initialize ACPI BIOS
B9h		Prepare Boot
BAh		Initialize SMBIOS
BBh		Initialize PnP Option ROMs
BCh		Clear parity checkers
BDh		Display MultiBoot menu
BEh		Clear screen (optional)
BFh		Check virus and backup reminders
C0h		Try to boot with INT 19
C1h		Initialize POST Error Manager (PEM)
C2h		Initialize error logging
C3h		Initialize error display function
C4h		Initialize system error handler
C5h		PnPnd dual CMOS (optional)
C6h		Initialize notebook docking (optional)
C7h		Initialize notebook docking late
C8h		Force check (optional)
C9h		Extended checksum (optional)
CAh		Redirect Int 15h to enable remote keyboard
CBh		Redirect Int 13h to Memory Technologies Devices such as ROM, RAM, PCMCIA, and serial disk.
CCh		Redirect Int 10h to enable remote serial video
CDh		Re-map I/O and memory for PCMCIA
CEh		Initialize digitizer and display message.
D2h		Unknown interrupt
The following are for boot block in Flash ROM		
E0h		Initialize the chipset
E1h		Initialize the bridge
E2h		Initialize the CPU
E3h		Initialize the system timer
E4h		Initialize system I/O
E5h		Check force recovery boot
E6h		Checksum BIOS ROM
E7h		Go to BIOS
E8h		Set Huge Segment

---

Code	Beeps	POST Routine Description
E9h		Initialize Multi Processor
EAh		Initialize OEM special code
EBh		Initialize PIC and DMA
ECh		Initialize Memory type
EDh		Initialize Memory size
EEh		Shadow Boot Block
EFh		System memory test
F0h		Initialize interrupt vectors
F1h		Initialize Run Time Clock
F2h		Initialize video
F3h		Initialize System Management Mode
F4h	1	Output one beep
F5h		Clear Huge Segment
F6h		Boot to Mini DOS
F7h		Boot to Full DOS

# Index of Symptom-to-FRU Error Message

## LCD-Related Symptoms

Symptom/Error	Action in Sequence
LCD backlight doesn't work. LCD is too dark. LCD brightness cannot be adjusted. LCD contrast cannot be adjusted.	Enter BIOS Utility to execute "Load Setup Default Settings", then reboot system. Reconnect the LCD connectors. Keyboard (if contrast and brightness function key do not work). LCD inverter ID LCD cable LCD inverter LCD System board
Unreadable LCD screen Missing pels in characters Abnormal screen Wrong color displayed	Reconnect the LCD connector. LCD inverter ID LCD cable LCD inverter LCD System board
LCD has extra horizontal or vertical lines displayed.	LCD inverter ID LCD inverter LCD cable LCD System board

## Indicator-Related Symptoms

Symptom/Error	Action in Sequence
Indicator incorrectly remains off or on, but system runs correctly.	Reconnect the inverter board Inverter board System board

## Power-Related Symptoms

Symptom/Error	Action in Sequence
Power shuts down during operation.	Power source (battery pack and power adapter). See "Power System Check". Battery pack Power adapter Hard drive & battery connection board System board
The system doesn't power on.	Power source (battery pack and power adapter). See "Power System Check". Battery pack Power adapter Hard drive & battery connection board System board

### Power-Related Symptoms

Symptom/Error	Action in Sequence
The system doesn't power-off.	Power source (battery pack and power adapter). See Power System Check". Hold and press the power switch for more than 4 seconds. System board
Battery can't be charged.	See "Check the Battery Pack". Battery pack System board

### PCMCIA-Related Symptoms

Symptom/Error	Action in Sequence
System cannot detect the PC Card (PCMCIA).	PCMCIA slot assembly System board
PCMCIA slot pin is damaged.	PCMCIA slot assembly

### Memory-Related Symptoms

Symptom / Error	Action in Sequence
Memory count (size) appears different from actual size.	Enter BIOS Setup Utility to execute "Load Default Settings, then reboot system. DIMM System board

### Speaker-Related Symptoms

Symptom/Error	Action in Sequence
In Windows, multimedia programs, no sound comes from the computer.	Audio driver Speaker System board
Internal speakers make noise or emit no sound.	Speaker System board

### Power Management-Related Symptoms

Symptom/Error	Action in Sequence
The system will not enter hibernation.	Keyboard (if control is from the keyboard) Hard disk drive System board
The system does not enter hibernation mode and four short beeps every minute.	Press Fn + F4 and see if the computer enters hibernation mode. Touchpad Keyboard Hard disk connection board Hard disk drive System board

### Power Management-Related Symptoms

Symptom/Error	Action in Sequence
The system does not enter standby mode after closing the LCD.	LCD cover switch System board
The system does not resume from hibernation mode.	Hard disk connection board Hard disk drive System board
The system does not resume from standby mode after opening the LCD.	LCD cover switch System board
Battery fuel gauge in Windows does not go higher than 90%.	Remove battery pack and let it cool for two hours. Refresh battery (continue to use battery until power off, then charge battery). Battery pack System board
System hangs intermittently.	Reconnect hard disk/CD-ROM drives. Hard disk connection board System board

### Peripheral-Related Symptoms

Symptom/Error	Action in Sequence
System configuration does not match the installed devices.	Enter BIOS Setup Utility to execute "Load Default Settings", then reboot system. Reconnect hard disk/CD-ROM/diskette drives.
External display does not work correctly.	Press Fn + F5, LCD/CRT/Both display switching System board
USB does not work correctly.	System board
Print problems	Ensure the "Parallel Port" in the "Onboard Devices Configuration" of BIOS Setup Utility is set to Enabled. Onboard Devices Configuration Run printer self-test. Printer driver Printer cable Printer System Board
Serial or parallel port device problems.	Ensure the "Serial Port" in the Devices Configuration" of BIOS Setup Utility is set to Enabled. Device driver Device cable Device System board

### Keyboard/Touchpad-Related Symptoms

Symptom/Error	Action in Sequence
Keyboard (one or more keys) does not work.	Reconnect the keyboard cable. Keyboard System board



---

### Keyboard/Touchpad-Related Symptoms

Symptom/Error	Action in Sequence
Touchpad does not work.	Reconnect touchpad cable. Touchpad board System board

### Modem-Related Symptoms

Symptom/Error	Action in Sequence
Internal modem does not work correctly.	Modem phone port modem combo board System board

**NOTE:** If you can not correct the problems according to the anterior tables, see “Undetermined Problems”.

---

## ***Intermittent Problems***

Intermittent system hang problems can be caused by a variety of reasons that have nothing to do with a hardware defect, such as cosmic radiation, electrostatic discharge, or software errors. FRU replacement should be considered only when a recurring problem exists.

When analyzing an intermittent problems, follow the procedures below:

1. Run the advanced diagnostic test for the system board in loop mode at least 10 times.
2. If no error is detected, do not replace any FRU.
3. If any error is detected, replace the FRU. Rerun the test to verify that there are no more errors.

---

## ***Undetermined Problems***

The diagnostic problems does not identify which devices fail, which devices are incorrectly installed, whether a short circuit happens, or whether the system is inoperative.

**NOTE:** Verify if all devices attached are supported by the computer.

**NOTE:** Verify if the power supply used at the time of failure is operating correctly. You can refer to “Power System Check”.

Follow the procedures below to isolate the failing FRU. Do not isolate non-defective FRU.

1. Power off the computer.
2. Visually check the devices. If any problems are found, replace the FRU.
3. Remove or disconnect all of the following devices:
  - Non-Acer devices
  - Printer, mouse, and other external devices
  - Battery Pack
  - Hard disk drive
  - DIMM
  - CD-ROM / Diskette drive module
  - PC cards
4. Power on the computer.
5. Determine if the problem has been resolved.
6. If the problem does not recur, reconnect the removed devices one at a time until you find the failed FRU.
7. If the problem remains, replace the following FRU one at a time. Do not replace a non-defective FRU.
  - System board
  - LCD assembly

## Jumper and Connector Location

### Top View

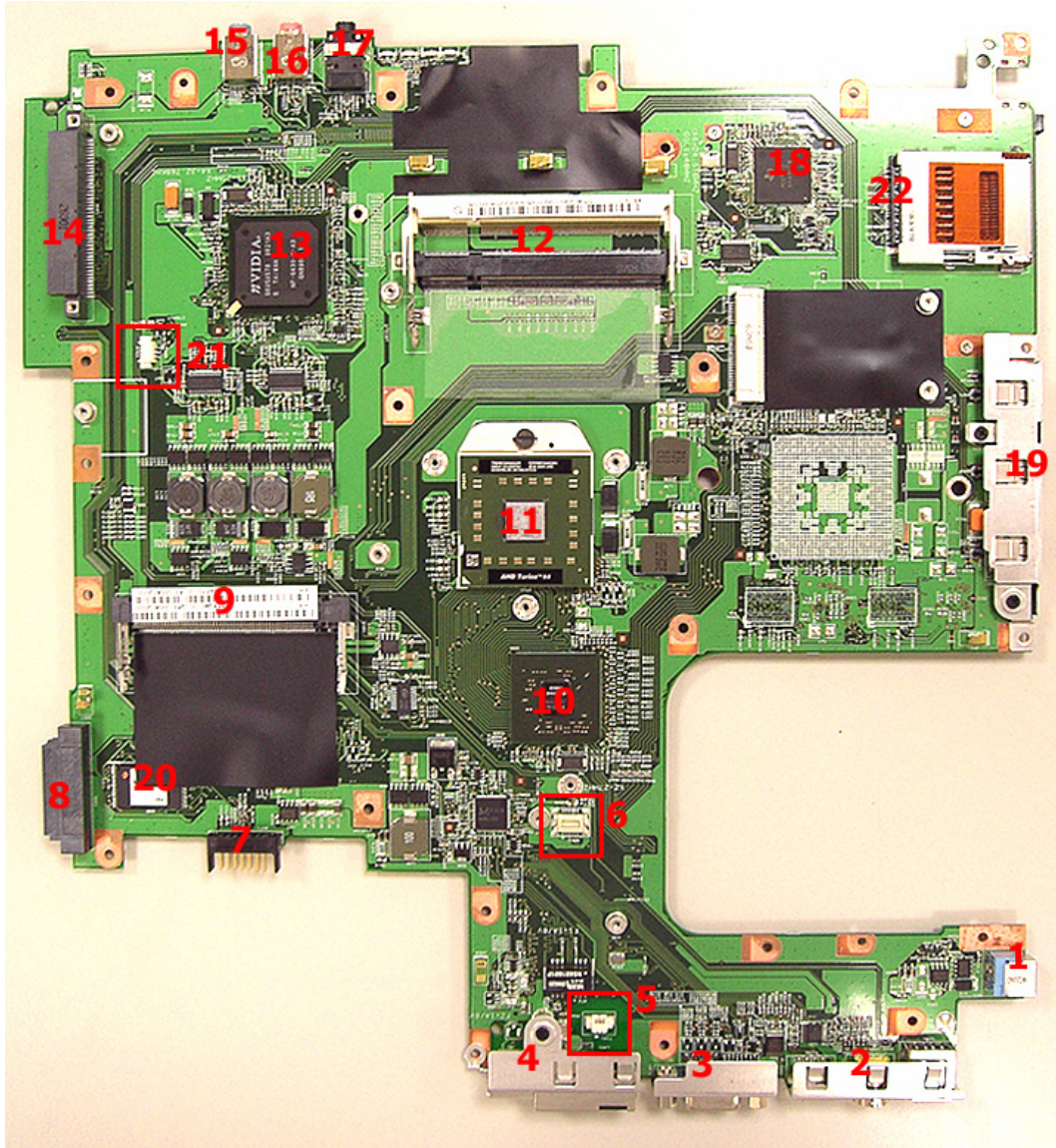

No.	Description	No.	Description
1	DC-in jack	2	USB connector
3	CRT connector	4	RJ11 & RJ45 connector
5	MDC module cable connector	6	MDC board connector
7	Main battery connector	8	ODD connector
9	Mini PCI slot	10	North bridge
11	CPU	12	DIMM slot

---

No.	Description	No.	Description
13	South bridge	14	HDD connector
15	Line-in jack	16	Microphone-in jack
17	Line-out jack	18	Cardbus controller
19	USB connector	20	BIOS ROM
21	RTC battery connector	22	5-in-1 card reader



## Bottom View

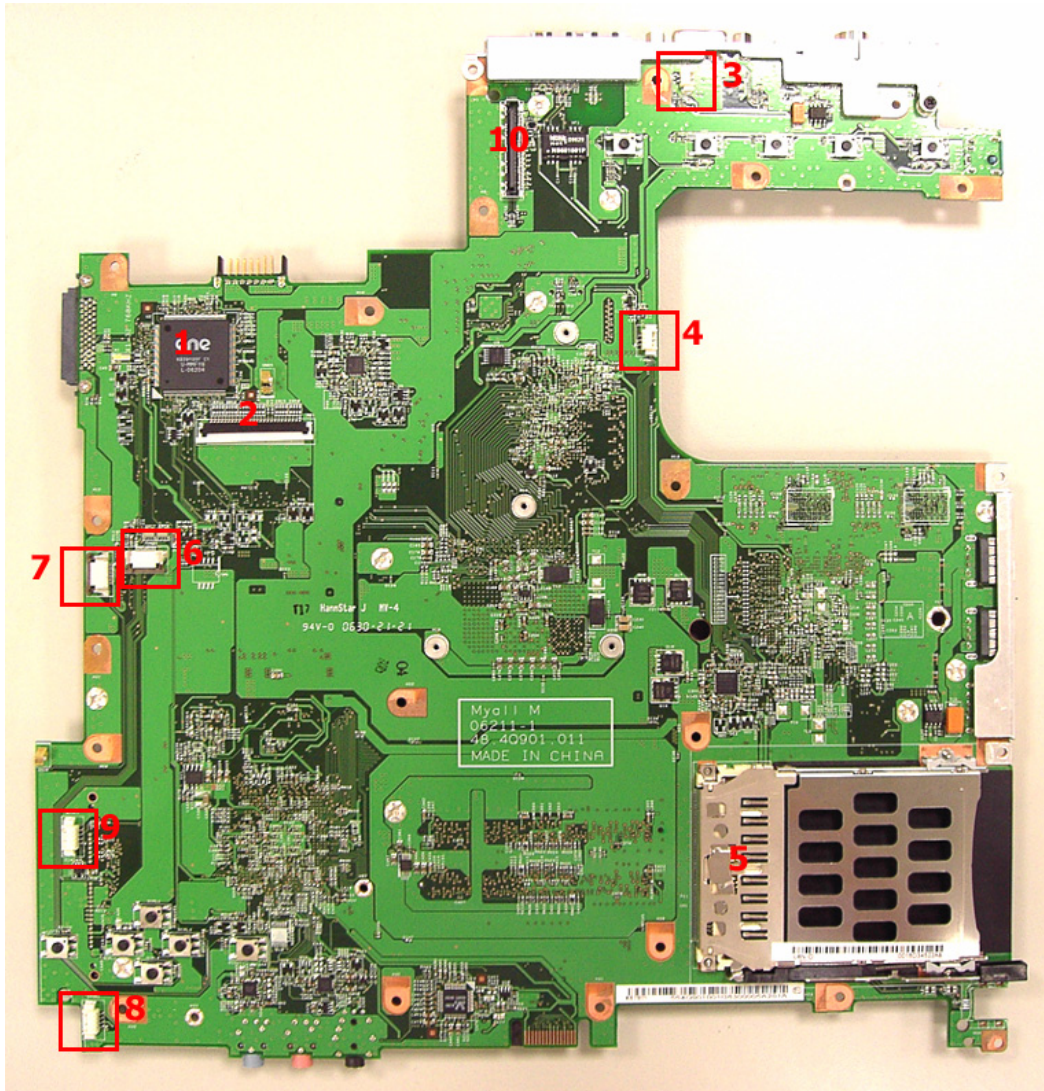

Item	Description	Item	Description
1	Keyboard controller	2	Keyboard connector
3	Lid switch connector	4	System fan connector
5	PCMCIA card reader	6	Function key board connector
7	Touch pad board connector	8	Speaker connector
9	Bluetooth module connector	10	LCD cable connector

# Switch Setting

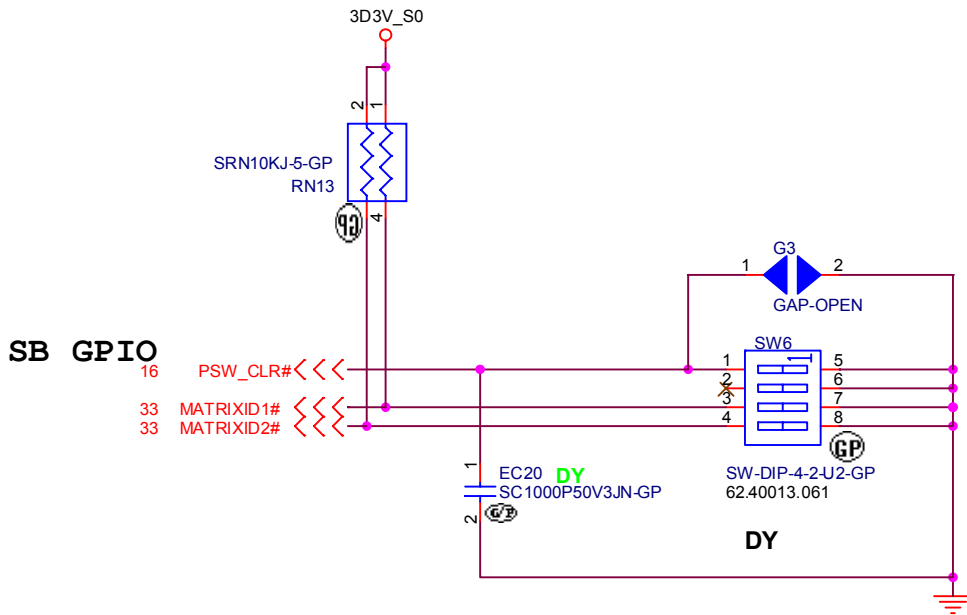

Short G3 to clear password.

---

## ***Password Bypassing & BIOS Recovery***

For RD and CSD to debug easilly, AS7000/9300 &TM7510provides one hardware PIN pad for bypassing Password Check, and one Hotkey to enable BIOS Recovery.

1. PIN pad: To short PIN pad to bypass password check.
2. Hotkey to enable BIOS Recovery: Fn+ESC, then Power Button, AC+DC coexistence is strongly recommended.

**Bypassing Password Check:** If the user has set Password ( power-on or setup password) for security reason, BIOS will check password during POST or when entering the BIOS setup menu. However, if it is necessary to ignore the password check, the user may enable short PIN Pad to bypass password check.

**BIOS Recovery:** Boot Block is a special block of BIOS. It is used to boot up the system with minimum BIOS initialization. The user can enable this feature to restore the BIOS to a successful one if previous BIOS flashing process fails.

1. PIN pad Location

AS7000/9300 &TM7510provides one hardware Pin pad under the keyboard. RD/CSD can enable this function by shorting this pad. The Pin Pad location should look as the figure below:



2. Clear Password

**PIN Pad:** Bypassing Password Check, Keep shorting G3 (2 triangle pad) as above PIN pad and then powering on the system will force the BIOS to clear Supervisor and User passwords. That means both the power-on and setup passwords are all cleared.

**HDD password clean:**

It uses on dos environment. To decode HDD password error code for unlock hard disk.

```
A\> unlock6 XXXX 00
```

```
XXXX -HDD password error code
```

```
Unlock6.exe v1.1 2 May 2003
```



---

Choice what kind of the password to be generated:

0) Exit

1) Scan code

2) Upper case ASCII Code

3) Lower case ASCII Code

Enter your choice 2 <- chose 2

XXXXXX

XXXXXX

XXXXXX

Those passwords are master password.

### 3. Restore BIOS by the Crisis Disk

Enter this function by Fn+ESC, and Power Button. To use this function, it is strongly recommended to have the coexistence of AC and Batter powers. If this function is enabled, the system will force the BIOS to enter a special BIOS block, called BootBlock. RD/CSD can use this special BIOS code to recover the BIOS to a successful one if previous BIOS flashing process fails. However, before doing this, one Crisis Disk should be prepared in WinXP. Detailed steps are as the followings,

- Prepare the Crisis Disk in WinXP (Crisis Disk will be released when BIOS V1.00 is released)
- Insert the Crisis Disk to a USB floppy drive which is attached to the failed machine.
- On the power-off state, press Fn+ESC and press button. The system should be powered on with Crisis Recovery process.
- BootBlock BIOS starts to restore the failed BIOS code. Short beeps should be heard when flashing.
- If the flashing process is finished, a long beep should be heard.
- Power down the system when Step 3.5 is finished.

If the crisis recovery process is finished, the system should be powered on with a successful BIOS. RD/CSD can then update the BIOS to a workable on by regular BIOS flashing process.

## ***FRU (Field Replaceable Unit) List***

---

This chapter offers the FRU (Field Replaceable Unit) list in global configuration of Aspire 9300/7000&TM7510. Refer to this chapter whenever ordering the parts to repair or for RMA (Return Merchandise Authorization).

Please note that when ordering FRU parts, you should check the most up-to-date information available on your regional web or channel. For whatever reasons a part number is changed, it will NOT be noted on the printed service guide. For Acer authorized service providers, your Acer office may have a different part number code from those given in the FRU list of this printed service guide. You **MUST** use the local FRU list provided by your regional Acer office to order FRU parts for service.

**NOTE:** To scrap or to return the defective parts, you should follow the local government ordinance or regulations on how to dispose them properly, or follow the rules set by your regional Acer office on how to return it.

# Exploded Diagram

PART NO	DESCRIPTION	QTY	REV	REMARK
60.450915.00	Myall Middle Cover ASSY(AS)	1	0A	
60.450916.00	myall_mhckovr_d_cover Assy	1	0A	
60.450919.00	myall_mhhd_cover Assy	1	0A	
60.45010.00	myall_mhpd_cover Assy	1	0A	
60.45011.00	myall_alhm_cover Assy	1	0A	
60.40914.00	Myall H L-case S-Video	1	0A	
65.40915.00	Myall M U-case TV	1	0A	
86.00252.72	TBD	17	0A	
86.54353.560	SCREW	2	0A	
86.94353.460	SCREW	24	0A	
86.24554.480	SCREW	3	0A	
KEYBRD.LT.Y	BTY	1	0A	
MYLL.M.20	Myall M LCD ASSY	1	0A	
MYLL.HD.1	HDU	1	0A	
MYLL.M.11	MB	1	0A	
MYLL.HD.1	DDU	1	0A	
MYLL.HD.1	Fan	1	0A	
	Keyboard	1	0	

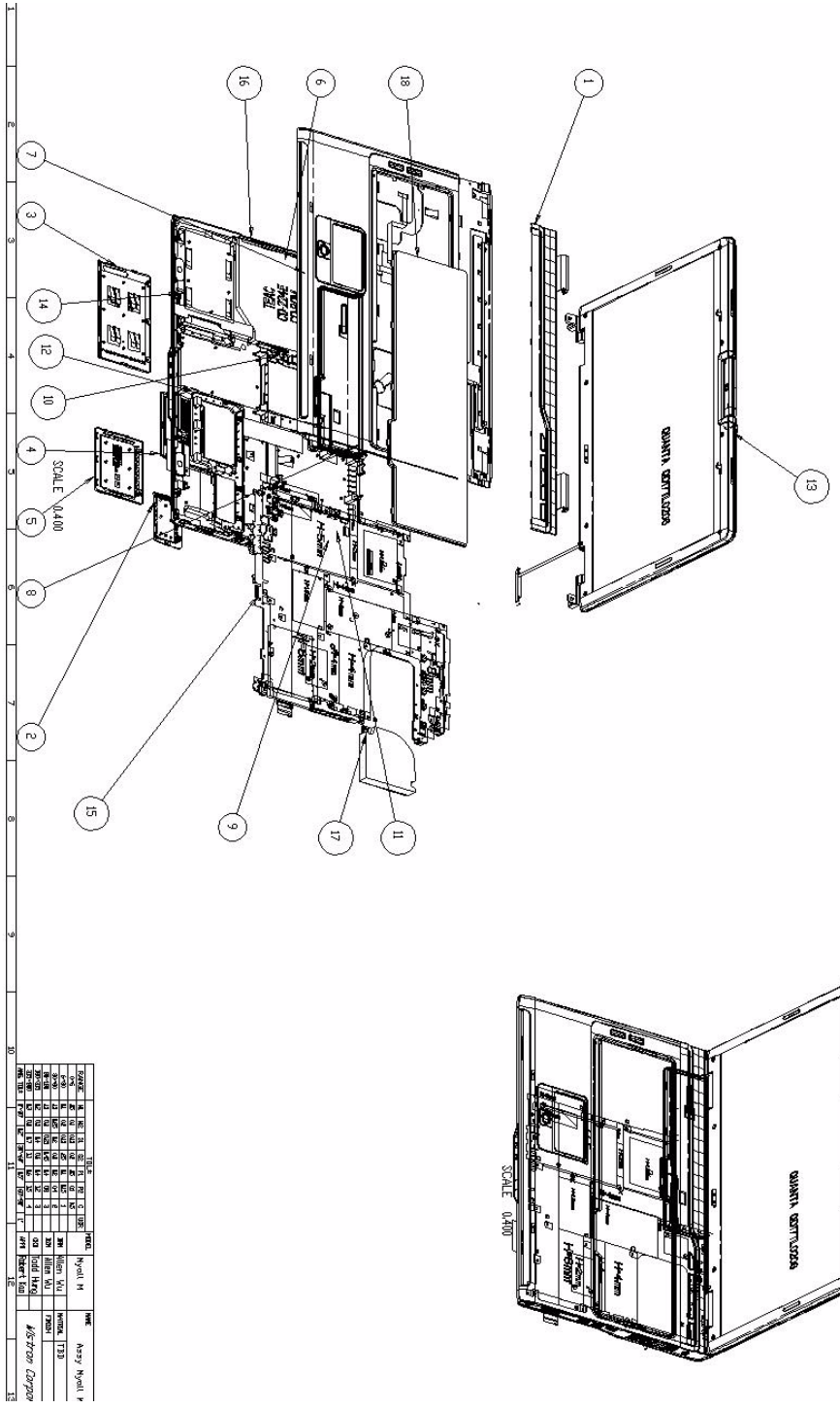

# Parts

## Aspire 9300 G72M FRU List

Category	Part Name	Description	Acer Part No.
<b>ADAPTER</b>			
ADAPTER	ADAPTER 90W LISHIN SLS0202C19A20LF	ADT 90W LISHIN SLS0202C19A20LF	AP.09006.004
ADAPTER	ADAPTER 90W DELTA ADP- 90SB BBDAF	ADT 90W DELTA ADP-90SB BBDAF	AP.09001.010
ADAPTER	ADAPTER 90W LITEON PA- 1900-24AR	ADT 90W LITEON PA-1900- 24AR	AP.09003.011
ADAPTER	ADAPTER 90W DELTA ADP- 90SB BBAAF	ADT 90W DELTA ADP-90SB BBAAF	AP.09001.004
ADAPTER	ADAPTER 90W LITEON PA- 1900-04WR	ADT 90W LITEON PA-1900- 04WR	AP.09003.005
<b>BATTERY</b>			
BATTERY	BATTERY PACK LI-MN 6CELL 2.0MAH SANYO	BTY PACK LI-MN 6C 2.0AH SANYO	BT.00603.021
BATTERY	BATTERY PACK LI+ 6CELL 2.0MAH SONY	BTY PACK LI+ 6C 2.0AH SONY	BT.00604.010
BATTERY	BATTERY PACK LI-MN 6CELL 2.0MAH P PANASONIC	BTY PACK LI-MN 6C 2.0AH PANA	BT.00605.005
BATTERY	BATTERY PACK LI+ 8CELL 2.4MAH SANYO	BTY PACK LI+ 8C 2.4AH SANYO	BT.00803.018
BATTERY	BATTERY PACK LI+ 8CELL 2.4MAH SONY	BTY PACK LI+ 8C 2.4AH SONY	BT.00807.010
<b>BOARDS</b>			
	WIRELESS LAN BOARD 802.11BG FOXCONN BCM4318	WLAN 802.11BG FOX BCM4318 MURA	54.A74V1.002
BOARDS	WIRELESS LAN BOARD 802.11BG FOXCONN ATHEROS EU	WLAN 802.11BG FOX ATHEROS EU	54.A74V1.001
BOARDS	WILELESS LAN BOARD 802.11BG FOXCONN BCM4311	WLAN 802.11BG BCM4311 WW SKU	54.AEFV1.001
	LED BOARD	MYALL M LED BD 06554- 1(DIP)	55.AEFV1.001
	TOUCHPAD BOARD SYNPATICM61PUF1G372	TOUCHPAD SYNPATICM61PUF1G372	56.A46V1.001
BOARDS	BLUETOOTH BOARD FOXCONN BCM2045 V01	BT MODULE FOXCONN BCM2045 V01	54.TB2V1.001

Category	Part Name	Description	Acer Part No.
	TV TUNER BOARD	TV TUNER MINIPCI M103 HYBRID	54.ADFV1.001
BOARDS	TV TUNER BOARD	TV TUNER MINIPCI M104 H/W ENCO	54.ADFV1.002
<b>CABLES</b>			
CABLES	POWER CORD 10A 125V US	CODE US 10A 125V BK	27.T30V1.001
CABLES	POWER CORD 10A 125V 3PIN US BK	CODE 10A 125V 3P US BK	27.01518.641
CABLES	POWER CORD 10A 3PIN BK DENMARK	CODE DENMARK 10A 3P BK	27.01518.561
CABLES	POWER CORD 10A 250V 3PIN DENMARK BK	CODE 10A 250V 3P DENMARK BK	27.01518.671
CABLES	POWER CORD 10A 250V 3PIN BK SOUTH AFRICA	CODE SOUTH AFRICA 10A 250V BK	27.01518.571
CABLES	POWER CORD 16A 250V SOUTH AFRICA BK	CODE 16A 250V SOUTH AFRICA BK	27.01518.681
CABLES	POWER CORD 10A 250V SWISS	CODE SWISS POWER 10A 250V BK	27.01518.581
CABLES	POWER CORD 10A 250V 3PIN SWISS BK	CODE 10A 250V 3P SWISS BK	27.01518.691
CABLES	POWER CORD 10A 250V 3PIN CHINA BK	CORD 10A 250V 3P CHINA BK	27.01518.701
CABLES	POWER CORD 10A 250V 3PIN ITALY	CORD ITALY 10A 250V 3P BK	27.01518.611
CABLES	POWER CORD 10A 250V 3PIN ITALY BK	CORD 10A 250V 3P ITALY BK	27.01518.711
CABLES	POWER CORD 2.5A 250V SOUTH AFRICA BK (INDIA)	CORD 2.5A 250V SOUTH AFRICA BK	27.01518.631
CABLES	POWER CORD 10A 250V SOUTH AFRICA BK (INDIA)	CORD 10A 250V SOUTH AFRICA BK	27.01518.721
CABLES	POWER CORD 220V 3PIN EUR	CORD EUR 220V 3P BK	27.T30V1.004
CABLES	POWER CABLE 16A 250V 3PIN EUR BK	CORD 16A 250V 3P EUR BK	27.01518.731
CABLES	POWER CORD 250V 10A 3PIN ISRAEL	CORD 250V 10~16A 3P ISRAEL	27.01518.761
CABLES	POWER CORD 2.5A 125V USA	CORD USA/W CNS 2.5A 125V 8121-	27.01518.781
CABLES	POWER CORD 3A 250V 3PIN UK	CODE UK 3A 250V 3P BK	27.01518.541
CABLES	POWER CORD 5A 250V 3PIN UK BK	CODE 5A 250V 3P UK BK	27.03118.001
CABLES	POWER CORD ACA / ACNZ	POWER CODE ACA / ACNZ ANNIE	27.03218.021
CABLES	POWER CORD 10A 250V 3PIN CHINA	CORD CHINA 10A 250V 3P	27.01518.591

Category	Part Name	Description	Acer Part No.
	TOUCHPAD CABLE	T/P FFC CABLE MYALL	50.AEFV1.001
CABLES	LAUNCH BOARD CABLE	LAUNCH BOARD FFC CABLE MYALL	50.AEFV1.002
<b>CASE/COVER/BRACKET ASSEMBLY</b>			
	MIDDLE COVER	ASSY MIDDLE COVER--AS MYALL	60.ACKV1.003
	MINI CARD COVER	ASSY MINICARD COVER MYALL	42.AEFV1.001
	HDD COVER	ASSY HDD COVER MYALL	42.AEFV1.002
	MINI PCI COVER	ASSY MINIPCI COVER MYALL	42.AEFV1.003
	DIMM COVER	ASSY DIMM COVER MYALL	42.AEFV1.004
	TOUCHPAD FRAME	KNOB T/P FRAME AS MYALL	42.ADFV1.003
	LOWER CASE W/SPEAKER	ASSY L-CASE S-VIDEO MYALL M	60.AEFV1.001
	SPEAKER LEFT/RIGHT	SPEAKER MYALL	23.TCBV1.001
	UPPER CASE W/COVER SWITCH CABLE	ASSY U-CASE S-VIDEO MYALL M	60.AEFV1.002
CABLES	COVER SWITCH CABLE	COVER SWITCH HT MYALL	50.TCBV1.004

Category	Part Name	Description	Acer Part No.
COMBO DRIVE	COMBO MODULE 24X	ASSY 24X COMBO LITEON MYALL M	6M.AEFV1.001
	OPTICAL BRACKET	ODD BRKT MYALL	33.TCBV1.002
	COMBO FRONT BEZEL	ASSY COMBO ODD BEZEL GBASE	42.AEFV1.011
COMBO DRIVE	CDRW/DVD COMBO DRIVE 24X LITEON SOSC-2485K W/O BEZEL	COMBO LIT/SOSC-2485K NO BZL	KO.02409.022
COMBO DRIVE	CDRW/DVD COMBO DRIVE 24X PHILIPS SCB5265 W/O BEZEL	COMBO PHI/SCB5265 MYALL NOBZL	KO.02408.010
<b>CPU/PROCESSOR</b>			
CPU/PROCESSOR	CPU NB TURION 64 X2 TL50 AMD	IC CPU NB TURION 64 X2 TL50	KC.TTL02.500
CPU/PROCESSOR	CPU NB TURION 64 X2 TL52 AMD	IC CPU NB TURION 64 X2 TL52	KC.TTL02.520
CPU/PROCESSOR	CPU NB TURION 64 X2 TL56 AMD	IC CPU NB TURION 64 X2 TL56	KC.TTL02.560
CPU/PROCESSOR	CPU NB TURION 64 X2 TL60 AMD	IC CPU NB TURION 64 X2 TL60	KC.TTL02.600
CPU/PROCESSOR	CPU NB TURION 64 MK36 31W AMD	IC CPU NB TURION64 MK36 31W	KC.TMK02.360
CPU/PROCESSOR	CPU SEMPRON 64 3200+ 25W AMD	IC CPU SEMPRON 64 3200+ 25W F	KC.S3202.25F
CPU/PROCESSOR	CPU SEMPRON 64 3400+ 25W AMD	IC CPU SEMPRON 64 3400+ 25W F	KC.S3402.25F
CPU/PROCESSOR	CPU SEMPRON 64 3500+ 25W AMD	IC CPU SEMPRON 64 3500+ 25W F	KC.S3502.25F
DVD-RW DRIVE	DVD-RW MODULE 8X SUPER MULTI	ASSY 24X COMBO PHILIPS MYALL M??	6M.AEFV1.002
CASE/COVER/BRACKET ASSEMBLY	OPTICAL BRACKET	ODD BRKT MYALL	33.TCBV1.002
CASE/COVER/BRACKET ASSEMBLY	DVD SUPER MULIA BEZEL	ASSY S_MULTI ODD BEZEL GBASE	42.TCBV1.013
DVD-RW DRIVE	DVD-RW DRIVE 8X SUPER MULTI PHILIPS SDVD-8821 W/O BEZEL	SUP-MULT PHI/SDVD-8821 KERKINI	KU.00809.005
DVD-RW DRIVE	DVD-RW DRIVE 8X SUPER MULTI LITEON SSM-8515S W/O BEZEL	S-MULTI LTN/SSM-8515S MYALL/2	KU.00804.037
DVD-RW DRIVE	DVD-RW DRIVE 8X SUPER MULTI TOSHIBA TS-L632D W/O BEZEL	S-MULT 8X TST/TS-L632D W/O BZL	KU.00801.014

Category	Part Name	Description	Acer Part No.
DVD-RW DRIVE	DVD-RW DRIVE 8X SUPER MULTI GBASE LITEON SSM-8515S W/O BEZEL	S-MULTI LTN/SSM-8515S BOLSEN-E	KU.00804.022
DVD-RW DRIVE	DVD-RW DRIVE 8X SUPER MULTI GBASE LITEON SSM-8515S W/O BEZEL	S-MULTI LTN/SSM-8515S GARDA5	KU.00804.038
FAN	FAN	FAN SUNON MYALL	23.TCBV1.004
HAETSINK	CPU HEATSINK W/O FAN	ASSY HSINK ROBIN DIS MYALL M	34.AF2V1.001
<b>HDD/HARD DISK DRIVE</b>			
HDD/HARD DISK DRIVE	HDD 60G 5400RPM PATA	ASSY HGST 60G 5400RPM PATA	
	HDD CHASSIS	ASSY HDD CHASSIS MYALL	33.TCBV1.003
	HDD 60G 5400RPM HITACHI HTS541260H9AT00	HDD 60GB HGST HTS541060G9AT00	KH.06007.011
HDD/HARD DISK DRIVE	HDD 60G 5400RPM TOSHIBA	HDD 60G 5400RPM TOSHIBA	KH.06004.007
HDD/HARD DISK DRIVE	HDD 60G 5400RPM SEAGATE ST96812A	HDD 60GB SEAGATE ST96812A	KH.06001.007
HDD/HARD DISK DRIVE	HDD 60G 5400RPM WD WD600UE-22KVTO	HDD 60GB WD WD600UE-22KVTO	KH.06008.004
HDD/HARD DISK DRIVE	HDD 80G 5400RPM PATA	HDD 80G 5400RPM PATA	
CASE/COVER/ BRACKET ASSEMBLY	HDD CHASSIS	ASSY HDD CHASSIS MYALL	33.TCBV1.003
HDD/HARD DISK DRIVE	HDD 80G 5400RPM HITACHI	"HDD 80G 2.5"" 5400RPM HGST"	KH.08007.013
HDD/HARD DISK DRIVE	HDD 80G 5400RPM TOSHIBA	HDD 80GB TOSHIBA 5400RPM	KH.08004.006
HDD/HARD DISK DRIVE	HDD 80G 5400RPM SEAGATE ST98823A	HDD 80GB SEAGATE ST98823A	KH.08001.022
HDD/HARD DISK DRIVE	HDD 80G 5400RPM WD WD800UE-22KVTO	HDD 80GB WD WD800UE-22KVTO	KH.08008.029
HDD/HARD DISK DRIVE	HDD 100G 5400RPM PATA	ASSY HGST 100G 5400RPM PATA	
CASE/COVER/ BRACKET ASSEMBLY	HDD CHASSIS	ASSY HDD CHASSIS MYALL	33.TCBV1.003
HDD/HARD DISK DRIVE	HDD 100G 5400RPM HITACHI 13G1591 ROHS	HDD 100GB HGST 13G1591 ROHS	KH.10007.004



Category	Part Name	Description	Acer Part No.
HDD/HARD DISK DRIVE	HDD 100G 5400RPM TOSHIBA MK1032GAX	HDD 100GB TOSHIBA MK1032GAX	KH.10004.002
HDD/HARD DISK DRIVE	HDD 100G 5400RPM SEAGATE ST9100824A	HDD 100GB SEAGATE ST9100824A	KH.10001.007
HDD/HARD DISK DRIVE	HDD 100G 5400RPM WD WD1000UE-22KVT0	HDD 100GB WD WD1000UE-22KVT0	KH.10008.001
HDD/HARD DISK DRIVE	HDD 120G 5400RPM PATA	ASSY SEAGATE 120G 5400RPM PATA	
CASE/COVER/ BRACKET ASSEMBLY	HDD CHASSIS	ASSY HDD CHASSIS MYALL	33.TCBV1.003
HDD/HARD DISK DRIVE	HDD 120G 5400RPM HITACHI HTS541612J9AT00	HDD 120GB HGST HTS541612J9AT00	KH.12007.009
HDD/HARD DISK DRIVE	HDD 120G 5400RPM TOSHIBA	HDD 120GB TOSHIBA 5400RPM	KH.12004.002
HDD/HARD DISK DRIVE	HDD 120G 5400RPM SEAGATE ST9120821A	HDD 120GB SEAGATE ST9120821A	KH.12001.024
HDD/HARD DISK DRIVE	HDD 120G 5400RPM WD WD1200UE-22KVT0	HDD 120GB WD WD1200UE-22KVT0	KH.12008.015
HDD/HARD DISK DRIVE	HDD 160G 5400RPM PATA	HDD 160G 5400RPM PATA	
CASE/COVER/ BRACKET ASSEMBLY	HDD CHASSIS	ASSY HDD CHASSIS MYALL	33.TCBV1.003
<b>HDD</b>			
HDD	HDD 160G HITACHI HTS541616J9AT00	HDD 160GB HGST HTS541616J9AT00	KH.16007.010
HDD	HDD 160G SEAGATE ST9160821A	HDD 160GB SEAGATE ST9160821A	KH.16001.022
<b>KEYBOARD</b>			
KEYBOARD	KEYBOARD 105KEY DARFON SK-AFA3D US-IN	KB DARFON NSK-AFA3D US-IN 105K	KB.ACF07.001
KEYBOARD	KEYBOARD 105KEY DARFON NSK-AFA22 TAIWA	KB DARFON NSK-AFA22 TAIWA 105K	KB.ACF07.002
KEYBOARD	KEYBOARD 106KEY DARFON NSK-AFA2S SPANI	KB DARFON NSK-AFA2S SPANI 106K	KB.ACF07.003
KEYBOARD	KEYBOARD 105KEY DARFON NSK-AFA23 THAIL	KB DARFON NSK-AFA23 THAIL 105K	KB.ACF07.004
KEYBOARD	KEYBOARD 106KEY DARFON NSK-AFA3B BRALI	KB DARFON NSK-AFA3B BRALI 106K	KB.ACF07.005
KEYBOARD	KEYBOARD 105KEY DARFON NSK-AFA2K KOREA	KB DARFON NSK-AFA2K KOREA 105K	KB.ACF07.006
KEYBOARD	KEYBOARD 106KEY DARFON NSK-AFA2U UK	KB DARFON NSK-AFA2U UK 106K	KB.ACF07.007
KEYBOARD	KEYBOARD 106KEY DARFON NSK-AFA2G GERMA	KB DARFON NSK-AFA2G GERMA 106K	KB.ACF07.008
KEYBOARD	KEYBOARD 106KEY DARFON NSK-AFA2E ITALI	KB DARFON NSK-AFA2E ITALI 106K	KB.ACF07.009

Category	Part Name	Description	Acer Part No.
KEYBOARD	KEYBOARD 106KEY DARFON NSK-AFA2F FRENC	KB DARFON NSK-AFA2F FRENC 106K	KB.ACF07.010
KEYBOARD	KEYBOARD 106KEY DARFON NSK-AFA20 SWISS	KB DARFON NSK-AFA20 SWISS 106K	KB.ACF07.011
KEYBOARD	KEYBOARD 106KEY DARFON NSK-AFA26 PORTU	KB DARFON NSK-AFA26 PORTU 106K	KB.ACF07.012
KEYBOARD	KEYBOARD 105KEY DARFON NSK-AFA2A ARABI	KB DARFON NSK-AFA2A ARABI 105K	KB.ACF07.013
KEYBOARD	KEYBOARD 106KEY DARFON NSK-AFA3A BELGI	KB DARFON NSK-AFA3A BELGI 106K	KB.ACF07.014
KEYBOARD	KEYBOARD 106KEY DARFON NSK-AFA2W SWEDI	KB DARFON NSK-AFA2W SWEDI 106K	KB.ACF07.015
KEYBOARD	KEYBOARD 106KEY DARFON NSK-AFA2C CZECH	KB DARFON NSK-AFA2C CZECH 106K	KB.ACF07.016
KEYBOARD	KEYBOARD 106KEY DARFON NSK-AFA2Q HUNGA	KB DARFON NSK-AFA2Q HUNGA 106K	KB.ACF07.017
KEYBOARD	KEYBOARD 106KEY DARFON NSK-AFA2N NORWE	KB DARFON NSK-AFA2N NORWE 106K	KB.ACF07.018
KEYBOARD	KEYBOARD 106KEY DARFON NSK-AFA2D DANIS	KB DARFON NSK-AFA2D DANIS 106K	KB.ACF07.019
KEYBOARD	KEYBOARD 106KEY DARFON NSK-AFA2T TURKI	KB DARFON NSK-AFA2T TURKI 106K	KB.ACF07.020
KEYBOARD	KEYBOARD 106KEY DARFON NSK-AFA2M CA FR	KB DARFON NSK-AFA2M CA FR106K	KB.ACF07.022
KEYBOARD	KEYBOARD 105KEY DARFON NSK-AFA2L GREEK	KB DARFON NSK-AFA2L GREEK 105K	KB.ACF07.024
KEYBOARD	KEYBOARD 105KEY DARFON NSK-AFA2H HEBRE	KB DARFON NSK-AFA2H HEBRE 105K	KB.ACF07.025
KEYBOARD	KEYBOARD 105KEY DARFON NSK-AFA2R RUSSI	KB DARFON NSK-AFA2R RUSSI 105K	KB.ACF07.026
KEYBOARD	KEYBOARD 106KEY DARFON NSK-AFA3F SOLVE	KB DARFON NSK-AFA3F SOLVE 106K	KB.ACF07.027
MAINBOARD	MAINBOARD MYALL M G72 W/MODEM&MODEM CABLE&PCMCIA SLOT&RTC BATTERY W/O CPU&MEMORY	MYALL M MB 06211-1 G72 (D)	MB.AF201.001
PCMCIA SLOT/ PC CARD SLOT	PCMCIA SLOT 4PIN	CONN CARDBUS 4P 59330- 00L0C	22.T28V1.001
BATTERY	RTC BATTERY	BTY RTC MITSUBISHI ROHS	23.TCBV1.003
CABLES	MODEM CABLE	MDC CABLE HT MYALL	50.TCBV1.006
BOARDS	MODEM BOARD FOXCONN MDC1.5 T60M845.02 ROHS	MODEM MDC1.5 T60M845.02 ROHS	54.ABAV1.001
	"LCD MODULE 17.1"" WXGA NONE-GLARE CCD 300K"	ASSY 17.1 WXGA AUO+G MYALL M	6M.AEFV1.011

Category	Part Name	Description	Acer Part No.
	"INVERTER BOARD 15.4"" YEC YNV-W02"	"INVERTER 17"" YEC YNV- W02"	19.TB2V1.001
BOARDS	INVERTER BOARD DARFON VK.21189.402	INVERTER 17" VK.21189.402	19.TCBV1.001
BOARDS	"INVERTER BOARD 17"" O2 V189-601"	"INVERTER 17"" O2 V189- 601"	19.ADFV1.001
CABLES	"LCD CABLE 17.1"" WXGA"	"C.A. 17.1"" WXGA HT MYALL-2"	50.AEFV1.003
CAMERA	CAMERA CMOS 300K VFA BN2QA350K8SD79	CAMERA CMOS VFA BN2QA350K8SD79	56.ADFV1.001
	LCD BRACKET RIGHT	BRKT-R LCD MYALL-2	33.ADFV1.001
	LCD BARCKET LEFT	BRKT-L LCD MYALL-2	33.ADFV1.002
CASE/COVER/ BRACKET ASSEMBLY	CAMERA LATCH	LATCH CAMERA HINGH KIRKINI	33.AEFV1.001
CASE/COVER/ BRACKET ASSEMBLY	CAMERA UPPER CASE	CAS CAMERA L-CASE KIRKINI	60.AEFV1.006
CASE/COVER/ BRACKET ASSEMBLY	CAMERA SIDE HOLDER	HLDR CAMERA SIDE RIM KIRKINI	42.AEFV1.006
CASE/COVER/ BRACKET ASSEMBLY	CAMERA CAP HOLDER	HLDR CAMERA CAP KIRKINI	42.AEFV1.007
CASE/COVER/ BRACKET ASSEMBLY	"LCD PANEL 17.1"" W/ HINGE&LOGO"	"ASSY LCD 17.1"" PANEL CCD AS"	60.AEFV1.005
CASE/COVER/ BRACKET ASSEMBLY	LCD HINGE PACK LEFT/ RIGHT	LCD HINGE PACK LEFT/ RIGHT	6K.ADFV1.001
CASE/COVER/ BRACKET ASSEMBLY	"LCD BEZEL 17.1"" W/LOGO"	ASSY LCD BEZEL MYALL2	60.AEFV1.004

Category	Part Name	Description	Acer Part No.
CASE/COVER/ BRACKET ASSEMBLY	CAMERA LOWER CASE	ASSY CAMERA LCASE 300K MYALL-2	60.AEFV1.007
COMMUNICATIO N MODULE	WIRELESS ANTENNA LEFT/ RIGHT	ANTENNA CABLE MYALL	25.TCBV1.001
LCD	"LCD 17"" WXGA+ CMO N170C2-L01 NONE-GLARE"	"LCD 17"" WXGA+ CMO N170C2-L01"	LK.1700D.005
LCD	"LCD 17"" WXGA+ LG LP171WP4-TL01 NONE- GLARE"	"LCD 17"" WXGA+ LP171WP4-TL01"	LK.17008.019
LCD	"LCD 17.1"" WXGA+ SAMSUNG LTN170WX-L05 NONE GLARE"	"LCD 17""W LTN170WX-L05"	LK.17106.001
LCD	"LCD 17.1"" WXGA+ AUO B170PW03 V3 NONE GLARE"	"LCD 17""W AU B170PW03 V3"	LK.17105.006
LCD	"LCD 17.1"" WXGA+ QDI QD17TL02-05 NONE GLARE"	"LCD 17""W QDI QD17TL02- 05"	LK.17109.001
LCD	"LCD MODULE 17.1"" WXGA GLARE CCD 300K"	ASSY 17.1 WXGA AUO+G MYALL M	6M.AEFV1.021
BOARDS	"INVERTER BOARD 15.4"" YEC YNV-W02"	"INVERTER 17"" YEC YNV- W02"	19.TB2V1.001
BOARDS	INVERTER BOARD DARFON VK.21189.402	INVERTER 17" VK.21189.402	19.TCBV1.001
BOARDS	"INVERTER BOARD 17"" O2 V189-601"	"INVERTER 17"" O2 V189- 601"	19.ADFV1.001
CABLES	"LCD CABLE 17.1"" WXGA"	"C.A. 17.1"" WXGA HT MYALL-2"	50.AEFV1.003
CAMERA	CAMERA CMOS 300K VFA BN2QA350K8SD79	CAMERA CMOS VFA BN2QA350K8SD79	56.ADFV1.001
CASE/COVER/ BRACKET ASSEMBLY	LCD BRACKET RIGHT	BRKT-R LCD MYALL-2	33.ADFV1.001
CASE/COVER/ BRACKET ASSEMBLY	LCD BARCKET LEFT	BRKT-L LCD MYALL-2	33.ADFV1.002
CASE/COVER/ BRACKET ASSEMBLY	CAMERA LATCH	LATCH CAMERA HINGH KIRKINI	33.AEFV1.001
CASE/COVER/ BRACKET ASSEMBLY	CAMERA UPPER CASE	CAS CAMERA L-CASE KIRKINI	60.AEFV1.006
CASE/COVER/ BRACKET ASSEMBLY	CAMERA SIDE HOLDER	HLDR CAMERA SIDE RIM KIRKINI	42.AEFV1.006
CASE/COVER/ BRACKET ASSEMBLY	CAMERA CAP HOLDER	HLDR CAMERA CAP KIRKINI	42.AEFV1.007
CASE/COVER/ BRACKET ASSEMBLY	"LCD PANEL17.1"" W/ HINGE&LOGO"	"ASSY LCD 17.1"" PANEL CCD AS"	60.AEFV1.005

Category	Part Name	Description	Acer Part No.
CASE/COVER/ BRACKET ASSEMBLY	LCD HINGE PACK LEFT/ RIGHT	LCD HINGE PACK LEFT/ RIGHT	6K.ADFV1.001
CASE/COVER/ BRACKET ASSEMBLY	"LCD BEZEL 17.1"" W/LOGO"	ASSY LCD BEZEL MYALL2	60.AEFV1.004
CASE/COVER/ BRACKET ASSEMBLY	CAMERA LOWER CASE	ASSY CAMERA LCASE 300K MYALL-2	60.AEFV1.007
COMMUNICATIO N MODULE	WIRELESS ANTENNA LEFT/ RIGHT	ANTENNA CABLE MYALL	25.TCBV1.001
LCD	"LCD 17"" WXGA+ LG LP171WP4-TL03 GLARE"	"LCD 17"" WXGA+ LP171WP4-TL03"	LK.17008.020
LCD	"LCD 17"" WXGA+G CMO N170C2-L02"	"LCD 17"" WXGA+G CMO N170C2-L02"	LK.1700D.006
LCD	"LCD 17"" WXGA+ SAMSUNG LTN170WX-L05-H GLARE"	"LCD 17""W LTN170WX-L05- H GLARE"	LK.17106.002
LCD	"LCD 17"" WXGA+ AU B170PW03 V4 GLARE"	"LCD 17""WXGA B170PW03 V4 GLARE"	LK.17105.005
LCD	"LCD 17"" WXGA+ LG LP171WP4-TL02 GLARE"	"LCD 17""W LP171WP4-TL02 GLARE"	LK.17008.015
LCD	"LCD 17""WXGA+ QDI QD17TL02-06 GLARE"	"LCD 17"" QD17TL02-06 GLARE"	LK.17109.002
<b>MEMORY</b>			
MEMORY	SDIMM 1G HYNIX HYMP512S64BP8-C4	SODIMM 1G HYMP512S64BP8-C4	KN.1GB0G.002
MEMORY	SDIMM 1G INFINEON HYS64T128021HDL-3.7-B	SODIMM1G HYS64T128021HDL-3.7-B	KN.1GB02.030
MEMORY	SDIMM 1GB 533 NANYA	SO-DIMM DDRII 533 1GB NANYA	KN.1GB03.006
MEMORY	SDIMM 1GB DDRII667 NANYA NT1GT64U8HA0BN-3C	SODIMM 1G NT1GT64U8HA0BN-3C	KN.1GB03.009
MEMORY	SDIMM 1GB DDRII667 SAMSUNG M470T2953CZ3- CE6	SODIMM 1G M470T2953CZ3- CE6	KN.1GB0B.005
MEMORY	SDIMM 256M HYNIX HYMP532S64BP6-C4	SODIMM 256M HYMP532S64BP6-C4	KN.2560G.012
MEMORY	SDIMM 256MB DDRII533 NANYA NT256T64UH4A1FN- 37B	DIMM 256M NT256T64UH4A1FN-37B	KN.25603.029
MEMORY	SDIMM 256M INFINEON HYS64T32000HDL-3.7-A	SODIMM256MHYS64T32000 HDL-3.7-A	KN.25602.023
MEMORY	SDIMM 256M MICRON MT4HTF3264HY-53EB4	SODIMM 256M MT4HTF3264HY-53EB4	KN.25604.030
MEMORY	SDIMM 256MB DDRII533 SAMSUNG M470T3354CZ3- CD5	SODIMM 256M M470T3354CZ3-CD5	KN.2560B.017
MEMORY	SDIMM 256M HYNIX HYS64T32000HDL-3.7-B	SODIMM256MHYS64T32000 HDL-3.7-B	KN.25602.034
MEMORY	SDIMM 256MB DDRII667 HYNIX HYMP532S64BP6-Y5	SODIMM 256M HYMP532S64BP6-Y5	KN.2560G.013

Category	Part Name	Description	Acer Part No.
MEMORY	SDIMM 256MB DDRII667 NANYA NT256T64UH4A1FN-3C	SODIMM 256M NT256T64UH4A1FN-3C	KN.25603.027
MEMORY	SDIMM 512MB DDRII667 HYNIX HYMP564S64BP6-Y5	SODIMM 512M HYMP564S64BP6-Y5	KN.5120G.014
MEMORY	SDIMM 512M HYNIX HYMP564S64BP6-C4	SODIMM 512M HYMP564S64BP6-C4	KN.5120G.013
MEMORY	SDIMM 512M DDRII533 NANYA NT512T64UH8A1FN-37B	SODIMM512M NT512T64UH8A1FN-37B	KN.51203.023
MEMORY	SDIMM 512M INFINEON MHYS64T64020HDL-3.7-A	SODIMM512MHYS64T64020 HDL-3.7-A	KN.51202.021
MEMORY	SDIMM 512M DDRII533 ELPIDA GU33512AGEPN612C	SODIMM 512M GU33512AGEPN612C	KN.51209.005
MEMORY	SDIMM 512M DDRII533 SAMSUNG M470T6554CZ3-CD5	SODIMM 512M M470T6554CZ3-CD5	KN.5120B.015
MEMORY	SDIMM 512M HYNIX HYS64T64020HDL-3.7-B	SODIMM512MHYS64T64020 HDL-3.7-B	KN.51202.036
MEMORY	SDIMM 512MB DDRII667 NANYA NT512T64UH8A1FN-3C	SODIMM 512M NT512T64UH8A1FN-3C	KN.51203.025
<b>MICROPHONE</b>			
MICROPHONE	MICROPHONE	MICROPHONE FORGRAND MYALL	23.TCBV1.002
<b>MISCELLANEOUS</b>			
MISCELLANEOUS	LCD SCREW RUBBER	RUB LCD RUBBER CUSHION BOLSENA	47.A46V1.002
MISCELLANEOUS	LCD SCREW RUBBER	RUBBER SCREW MYALL	47.TCBV1.001
MISCELLANEOUS	LOGO PLATE	PLT LOGO PANEL	31.T49V1.001
MISCELLANEOUS	LOGO PLATE FOR BEZEL	"PLT BEZEL PLATE ""ACER "" LOGO"	31.A46V1.001
SCREWS	SCREW	SCW HEX NYL I#R-40/O#4-40 L5.5	34.00015.081
SCREWS	SCREW	SCREW MACH WAFER M2*L4 NI	86.T39V1.002
SCREWS	SCREW	SCREW M2*L3 (WHITE)	86.00C07.220
SCREWS	SCREW	SCREW M2*L3 NYLOK CR 3+	86.00E25.723
SCREWS	SCREW	SCREW M2*L3 NON-NYLOK CR3+	86.00E31.723
SCREWS	SCREW	SCREW M2.5*L6 NYLOK CR3+	86.00E33.736
SCREWS	SCREW	SCREW M2.5*L8 NYLOK CR3+	86.00E34.738
SCREWS	SCREW	SCREW M2*L8 NI NON- NYLOK	86.00E35.228
SCREWS	SCREW	SCREW M2*3 NYLON	86.00E94.723

Category	Part Name	Description	Acer Part No.
SCREWS	SCREW	SCRW M2.5X6 NON NYLOK BZN	86.00F01.736
SCREWS	SCREW	SCRW M2.5X5 NYLOK	86.00F19.735
SCREWS	SCREW	SCRW M2X4 NYLOK H0.3	86.00F24.724
SCREWS	SCREW	SCRW M2.5*L3(NON NYLOK)	86.9A523.3R0
SCREWS	SCREW	SCRW M2*4 WAFER NI	86.9A552.4R0
SCREWS	SCREW	SCREW NI M2*6L	86.9A552.6R0
SCREWS	SCREW	SCREW MACH WAFER M3*L4 NI	86.9A524.4R0

## Model Definition and Configuration

Model	Description	CPU	VGA Chip	HDD 1 (GB)	ODD
AS7003WSMi	AS7003WSMi XPHSA1 UMAC 1*512/100/6L/5R/CB_bg_0.3C_AN	SMP643425 W	UMA	N100GB5.4K	NSM8X
AS7003WSMi	AS7003WSMi XPHDK1 UMAC 1*512/100/6L/5R/CB_bg_0.3C_AN	SMP643425 W	UMA	N100GB5.4K	NSM8X
AS7003WSMi	AS7003WSMi XPHBE1 UMAC 1*512/100/6L/5R/CB_bg_0.3C_AN	SMP643425 W	UMA	N100GB5.4K	NSM8X
AS7003WSMi	AS7003WSMi XPHNL1 UMAC 1*512/100/6L/5R/CB_bg_0.3C_AN	SMP643425 W	UMA	N100GB5.4K	NSM8X
AS7003WSMi	AS7003WSMi XPHNO1 UMAC 1*512/100/6L/5R/CB_bg_0.3C_AN	SMP643425 W	UMA	N100GB5.4K	NSM8X
AS7003WSMi	AS7003WSMi XPHRU2 UMAC 1*512/100/6L/5R/CB_bg_0.3C_AN	SMP643425 W	UMA	N100GB5.4K	NSM8X
AS7003WSMi	AS7003WSMi XPHSV1 UMAC 1*512/100/6L/5R/CB_bg_0.3C_AN	SMP643425 W	UMA	N100GB5.4K	NSM8X
AS7003WSMi	AS7003WSMi XPHFRA UMAC 1*512/100/6L/5R/CB_bg_0.3C_AN	SMP643425 W	UMA	N100GB5.4K	NSM8X
AS7003WSMi	AS7003WSMi XPHDE7 UMAC 1*512/100/6L/5R/CB_bg_0.3C_AN	SMP643425 W	UMA	N100GB5.4K	NSM8X
AS7003WSMi	AS7003WSMi XPHCS2 UMAC 1*512/100/6L/5R/CB_bg_0.3C_AN	SMP643425 W	UMA	N100GB5.4K	NSM8X
AS7003WSMi	AS7003WSMi XPHHU6 UMAC 1*512/100/6L/5R/CB_bg_0.3C_AN	SMP643425 W	UMA	N100GB5.4K	NSM8X
AS7003WSMi	AS7003WSMi XPHPL6 UMAC 1*512/100/6L/5R/CB_bg_0.3C_AN	SMP643425 W	UMA	N100GB5.4K	NSM8X
AS7003WSMi	AS7003WSMi XPHSLO2 UMAC 1*512/100/6L/5R/CB_bg_0.3C_AN	SMP643425 W	UMA	N100GB5.4K	NSM8X
AS7003WSMi	AS7003WSMi XPHESA UMAC 1*512/100/6L/5R/CB_bg_0.3C_AN	SMP643425 W	UMA	N100GB5.4K	NSM8X
AS7003WSMi	AS7003WSMi XPHPT1 UMAC 1*512/100/6L/5R/CB_bg_0.3C_AN	SMP643425 W	UMA	N100GB5.4K	NSM8X
AS7003WSMi	AS7003WSMi XPHL1 UMAC 1*512/100/6L/5R/CB_bg_0.3C_AN	SMP643425 W	UMA	N100GB5.4K	NSM8X
AS7003WSMi	AS7003WSMi XPHIS1 UMAC 1*512/100/6L/5R/CB_bg_0.3C_AN	SMP643425 W	UMA	N100GB5.4K	NSM8X
AS7003WSMi	AS7003WSMi XPHIT1 UMAC 1*512/100/6L/5R/CB_bg_0.3C_AN	SMP643425 W	UMA	N100GB5.4K	NSM8X
AS7003WSMi	AS7003WSMi XPHTR1 UMAC 1*512/100/6L/5R/CB_bg_0.3C_AN	SMP643425 W	UMA	N100GB5.4K	NSM8X
AS7003WSMi	AS7003WSMi XPHAR1 UMAC 1*512/100/6L/5R/CB_bg_0.3C_AN	SMP643425 W	UMA	N100GB5.4K	NSM8X
AS7003WSMi	AS7003WSMi XPHSW5 UMAC 1*512/100/6L/5R/CB_bg_0.3C_AN	SMP643425 W	UMA	N100GB5.4K	NSM8X
AS7003WSMi	AS7003WSMi XPHUK1 UMAC 1*512/100/6L/5R/CB_bg_0.3C_AN	SMP643425 W	UMA	N100GB5.4K	NSM8X



Model	Description	CPU	VGA Chip	HDD 1 (GB)	ODD
AS7003WSMi	AS7003WSMi XPHSA1 UMAC 2*512/120/6L/5R/CB_bg_0.3C_AN	SMP643425 W	UMA	N120GB5.4K	NSM8X
AS7003WSMi	AS7003WSMi XPHDK1 UMAC 2*512/120/6L/5R/CB_bg_0.3C_AN	SMP643425 W	UMA	N120GB5.4K	NSM8X
AS7003WSMi	AS7003WSMi XPHBE1 UMAC 2*512/120/6L/5R/CB_bg_0.3C_AN	SMP643425 W	UMA	N120GB5.4K	NSM8X
AS7003WSMi	AS7003WSMi XPHFRA UMAC 2*512/120/6L/5R/CB_bg_0.3C_AN	SMP643425 W	UMA	N120GB5.4K	NSM8X
AS7003WSMi	AS7003WSMi XPHDE7 UMAC 2*512/120/6L/5R/CB_bg_0.3C_AN	SMP643425 W	UMA	N120GB5.4K	NSM8X
AS7003WSMi	AS7003WSMi XPHNL1 UMAC 2*512/120/6L/5R/CB_bg_0.3C_AN	SMP643425 W	UMA	N120GB5.4K	NSM8X
AS7003WSMi	AS7003WSMi XPHNO1 UMAC 2*512/120/6L/5R/CB_bg_0.3C_AN	SMP643425 W	UMA	N120GB5.4K	NSM8X
AS7003WSMi	AS7003WSMi XPHRU2 UMAC 2*512/120/6L/5R/CB_bg_0.3C_AN	SMP643425 W	UMA	N120GB5.4K	NSM8X
AS7003WSMi	AS7003WSMi XPHSV1 UMAC 2*512/120/6L/5R/CB_bg_0.3C_AN	SMP643425 W	UMA	N120GB5.4K	NSM8X
AS7003WSMi	AS7003WSMi XPHCS2 UMAC 2*512/120/6L/5R/CB_bg_0.3C_AN	SMP643425 W	UMA	N120GB5.4K	NSM8X
AS7003WSMi	AS7003WSMi XPHHU6 UMAC 2*512/120/6L/5R/CB_bg_0.3C_AN	SMP643425 W	UMA	N120GB5.4K	NSM8X
AS7003WSMi	AS7003WSMi XPHPL6 UMAC 2*512/120/6L/5R/CB_bg_0.3C_AN	SMP643425 W	UMA	N120GB5.4K	NSM8X
AS7003WSMi	AS7003WSMi XPHSLO2 UMAC 2*512/120/6L/5R/CB_bg_0.3C_AN	SMP643425 W	UMA	N120GB5.4K	NSM8X
AS7003WSMi	AS7003WSMi XPHESA UMAC 2*512/120/6L/5R/CB_bg_0.3C_AN	SMP643425 W	UMA	N120GB5.4K	NSM8X
AS7003WSMi	AS7003WSMi XPHPT1 UMAC 2*512/120/6L/5R/CB_bg_0.3C_AN	SMP643425 W	UMA	N120GB5.4K	NSM8X
AS7003WSMi	AS7003WSMi XPHL1 UMAC 2*512/120/6L/5R/CB_bg_0.3C_AN	SMP643425 W	UMA	N120GB5.4K	NSM8X
AS7003WSMi	AS7003WSMi XPHIS1 UMAC 2*512/120/6L/5R/CB_bg_0.3C_AN	SMP643425 W	UMA	N120GB5.4K	NSM8X
AS7003WSMi	AS7003WSMi XPHIT1 UMAC 2*512/120/6L/5R/CB_bg_0.3C_AN	SMP643425 W	UMA	N120GB5.4K	NSM8X
AS7003WSMi	AS7003WSMi XPHTR1 UMAC 2*512/120/6L/5R/CB_bg_0.3C_AN	SMP643425 W	UMA	N120GB5.4K	NSM8X
AS7003WSMi	AS7003WSMi XPHAR1 UMAC 2*512/120/6L/5R/CB_bg_0.3C_AN	SMP643425 W	UMA	N120GB5.4K	NSM8X
AS7003WSMi	AS7003WSMi XPHSW5 UMAC 2*512/120/6L/5R/CB_bg_0.3C_AN	SMP643425 W	UMA	N120GB5.4K	NSM8X
AS7003WSMi	AS7003WSMi XPHUK1 UMAC 2*512/120/6L/5R/CB_bg_0.3C_AN	SMP643425 W	UMA	N120GB5.4K	NSM8X
AS7003WSMi	AS7003WSMi XPHEN1 UMAC 1*512/100/6L/5R/CB_bg_0.3C_AN	SMP643425 W	UMA	N100GB5.4K	NSM8X
AS7003WSMi	AS7003WSMi XPHFR1 UMAC 1*512/100/6L/5R/CB_bg_0.3C_AN	SMP643425 W	UMA	N100GB5.4K	NSM8X
AS7003WSMi	AS7003WSMi XPHES1 UMAC 1*512/100/6L/5R/CB_bg_0.3C_AN	SMP643425 W	UMA	N100GB5.4K	NSM8X
AS7003WSMi	AS7003WSMi XPHXC1 UMAC 1*512/100/6L/5R/CB_bg_0.3C_AN	SMP643425 W	UMA	N100GB5.4K	NSM8X

Model	Description	CPU	VGA Chip	HDD 1 (GB)	ODD
AS7003WSMi	AS7003WSMi XPHAU1 UMAC 1*512/100/6L/5R/CB_bg_0.3C_AN	SMP643425 W	UMA	N100GB5.4K	NSM8X
AS7003WSMi	AS7003WSMi XPHFRA UMAC 2*512/100/6L/5R/CB_bg_0.3C_AN	SMP643425 W	UMA	N100GB5.4K	NSM8X
AS7003WSMi	AS7003WSMi MCEBE6 UMAC 2*512/120/6L/5R/CB_bg_0.3C_AN	SMP643425 W	UMA	N120GB5.4K	NSM8X
AS7003WSMi	AS7003WSMi MCECS5 UMAC 2*512/120/6L/5R/CB_bg_0.3C_AN	SMP643425 W	UMA	N120GB5.4K	NSM8X
AS7003WSMi	AS7003WSMi MCEAR1 UMAC 2*512/120/6L/5R/CB_bg_0.3C_AN	SMP643425 W	UMA	N120GB5.4K	NSM8X
AS7003WSMi	AS7003WSMi MCEAR2 UMAC 2*512/120/6L/5R/CB_bg_0.3C_AN	SMP643425 W	UMA	N120GB5.4K	NSM8X
AS7003WSMi	AS7003WSMi MCEDEA UMAC 2*512/120/6L/5R/CB_bg_0.3C_AN	SMP643425 W	UMA	N120GB5.4K	NSM8X
AS7003WSMi	AS7003WSMi MCEDEB UMAC 2*512/120/6L/5R/CB_bg_0.3C_AN	SMP643425 W	UMA	N120GB5.4K	NSM8X
AS7003WSMi	AS7003WSMi MCEESJ UMAC 2*512/120/6L/5R/CB_bg_0.3C_AN	SMP643425 W	UMA	N120GB5.4K	NSM8X
AS7003WSMi	AS7003WSMi MCEIT7 UMAC 2*512/120/6L/5R/CB_bg_0.3C_AN	SMP643425 W	UMA	N120GB5.4K	NSM8X
AS7003WSMi	AS7003WSMi MCEPL7 UMAC 2*512/120/6L/5R/CB_bg_0.3C_AN	SMP643425 W	UMA	N120GB5.4K	NSM8X
AS7003WSMi	AS7003WSMi MCENL6 UMAC 2*512/120/6L/5R/CB_bg_0.3C_AN	SMP643425 W	UMA	N120GB5.4K	NSM8X
AS7003WSMi	AS7003WSMi MCENO5 UMAC 2*512/120/6L/5R/CB_bg_0.3C_AN	SMP643425 W	UMA	N120GB5.4K	NSM8X
AS7003WSMi	AS7003WSMi MCEDK6 UMAC 2*512/120/6L/5R/CB_bg_0.3C_AN	SMP643425 W	UMA	N120GB5.4K	NSM8X
AS7003WSMi	AS7003WSMi MCEFRF UMAC 2*512/120/6L/5R/CB_bg_0.3C_AN	SMP643425 W	UMA	N120GB5.4K	NSM8X
AS7003WSMi	AS7003WSMi MCERU9 UMAC 2*512/120/6L/5R/CB_bg_0.3C_AN	SMP643425 W	UMA	N120GB5.4K	NSM8X
AS7003WSMi	AS7003WSMi MCESV5 UMAC 2*512/120/6L/5R/CB_bg_0.3C_AN	SMP643425 W	UMA	N120GB5.4K	NSM8X
AS7003WSMi	AS7003WSMi MCES11 UMAC 2*512/120/6L/5R/CB_bg_0.3C_AN	SMP643425 W	UMA	N120GB5.4K	NSM8X
AS7003WSMi	AS7003WSMi MCEPT6 UMAC 2*512/120/6L/5R/CB_bg_0.3C_AN	SMP643425 W	UMA	N120GB5.4K	NSM8X
AS7003WSMi	AS7003WSMi MCETR5 UMAC 2*512/120/6L/5R/CB_bg_0.3C_AN	SMP643425 W	UMA	N120GB5.4K	NSM8X
AS7003WSMi	AS7003WSMi MCESW8 UMAC 2*512/120/6L/5R/CB_bg_0.3C_AN	SMP643425 W	UMA	N120GB5.4K	NSM8X
AS7003WSMi	AS7003WSMi MCEUK5 UMAC 2*512/120/6L/5R/CB_bg_0.3C_AN	SMP643425 W	UMA	N120GB5.4K	NSM8X
AS7003WSMi	AS7003WSMi MCEWUK11W UMAC 2*512/120/6L/5R/CB_bg_0.3C_AN	SMP643425 W	UMA	N120GB5.4K	NSM8X
AS7003WSMi	AS7003WSMi MCEWIT11W UMAC 2*512/120/6L/5R/CB_bg_0.3C_AN	SMP643425 W	UMA	N120GB5.4K	NSM8X
AS7003WSMi	AS7003WSMi MCEWDE11W UMAC 2*512/120/6L/5R/CB_bg_0.3C_AN	SMP643425 W	UMA	N120GB5.4K	NSM8X
AS7003WSMi	AS7003WSMi MCEWFR11W UMAC 2*512/120/6L/5R/CB_bg_0.3C_AN	SMP643425 W	UMA	N120GB5.4K	NSM8X

Model	Description	CPU	VGA Chip	HDD 1 (GB)	ODD
AS9302WSMi	AS9302WSMi MCEBE6 NB7PSE128C 2*512/100/8L/5R/CB_bg_0.3C_AN	ATTL50	NB7 P-SE	N100GB5. 4K	NSM8X
AS9302WSMi	AS9302WSMi MCENL6 NB7PSE128C 2*512/100/8L/5R/CB_bg_0.3C_AN	ATTL50	NB7 P-SE	N100GB5. 4K	NSM8X
AS9302WSMi	AS9302WSMi MCENO5 NB7PSE128C 2*512/100/8L/5R/CB_bg_0.3C_AN	ATTL50	NB7 P-SE	N100GB5. 4K	NSM8X
AS9302WSMi	AS9302WSMi MCEDK6 NB7PSE128C 2*512/100/8L/5R/CB_bg_0.3C_AN	ATTL50	NB7 P-SE	N100GB5. 4K	NSM8X
AS9302WSMi	AS9302WSMi MCEFRF NB7PSE128C 2*512/100/8L/5R/CB_bg_0.3C_AN	ATTL50	NB7 P-SE	N100GB5. 4K	NSM8X
AS9302WSMi	AS9302WSMi MCEDEA NB7PSE128C 2*512/100/8L/5R/CB_bg_0.3C_AN	ATTL50	NB7 P-SE	N100GB5. 4K	NSM8X
AS9302WSMi	AS9302WSMi MCEDEB NB7PSE128C 2*512/100/8L/5R/CB_bg_0.3C_AN	ATTL50	NB7 P-SE	N100GB5. 4K	NSM8X
AS9302WSMi	AS9302WSMi MCEESJ NB7PSE128C 2*512/100/8L/5R/CB_bg_0.3C_AN	ATTL50	NB7 P-SE	N100GB5. 4K	NSM8X
AS9302WSMi	AS9302WSMi MCEIT7 NB7PSE128C 2*512/100/8L/5R/CB_bg_0.3C_AN	ATTL50	NB7 P-SE	N100GB5. 4K	NSM8X
AS9302WSMi	AS9302WSMi MCECS5 NB7PSE128C 2*512/100/8L/5R/CB_bg_0.3C_AN	ATTL50	NB7 P-SE	N100GB5. 4K	NSM8X
AS9303WSMi	AS9303WSMi MCEBE6 NB7PSE128C 2*512/120/8L/5R/CB_bg_0.3C_AN	ATTL52	NB7 P-SE	N120GB5. 4K	NSM8X
AS9302WSMi	AS9302WSMi MCETR5 NB7PSE128C 2*512/100/8L/5R/CB_bg_0.3C_AN	ATTL50	NB7 P-SE	N100GB5. 4K	NSM8X
AS9302WSMi	AS9302WSMi MCESW8 NB7PSE128C 2*512/100/8L/5R/CB_bg_0.3C_AN	ATTL50	NB7 P-SE	N100GB5. 4K	NSM8X
AS9302WSMi	AS9302WSMi MCEUK5 NB7PSE128C 2*512/100/8L/5R/CB_bg_0.3C_AN	ATTL50	NB7 P-SE	N100GB5. 4K	NSM8X
AS9302WSMi	AS9302WSMi MCERU9 NB7PSE128C 2*512/100/8L/5R/CB_bg_0.3C_AN	ATTL50	NB7 P-SE	N100GB5. 4K	NSM8X
AS9302WSMi	AS9302WSMi MCEV5 NB7PSE128C 2*512/100/8L/5R/CB_bg_0.3C_AN	ATTL50	NB7 P-SE	N100GB5. 4K	NSM8X
AS9302WSMi	AS9302WSMi MCEPL7 NB7PSE128C 2*512/100/8L/5R/CB_bg_0.3C_AN	ATTL50	NB7 P-SE	N100GB5. 4K	NSM8X
AS9302WSMi	AS9302WSMi MCES11 NB7PSE128C 2*512/100/8L/5R/CB_bg_0.3C_AN	ATTL50	NB7 P-SE	N100GB5. 4K	NSM8X
AS9302WSMi	AS9302WSMi MCEPT6 NB7PSE128C 2*512/100/8L/5R/CB_bg_0.3C_AN	ATTL50	NB7 P-SE	N100GB5. 4K	NSM8X
AS9303WSMi	AS9303WSMi MCEDK6 NB7PSE128C 2*512/120/8L/5R/CB_bg_0.3C_AN	ATTL52	NB7 P-SE	N120GB5. 4K	NSM8X
AS9303WSMi	AS9303WSMi MCEFRF NB7PSE128C 2*512/120/8L/5R/CB_bg_0.3C_AN	ATTL52	NB7 P-SE	N120GB5. 4K	NSM8X
AS9303WSMi	AS9303WSMi MCEDEA NB7PSE128C 2*512/120/8L/5R/CB_bg_0.3C_AN	ATTL52	NB7 P-SE	N120GB5. 4K	NSM8X
AS9303WSMi	AS9303WSMi MCEDEB NB7PSE128C 2*512/120/8L/5R/CB_bg_0.3C_AN	ATTL52	NB7 P-SE	N120GB5. 4K	NSM8X
AS9303WSMi	AS9303WSMi MCEESJ NB7PSE128C 2*512/120/8L/5R/CB_bg_0.3C_AN	ATTL52	NB7 P-SE	N120GB5. 4K	NSM8X
AS9303WSMi	AS9303WSMi MCEIT7 NB7PSE128C 2*512/120/8L/5R/CB_bg_0.3C_AN	ATTL52	NB7 P-SE	N120GB5. 4K	NSM8X

Model	Description	CPU	VGA Chip	HDD 1 (GB)	ODD
AS9303WSMi	AS9303WSMi MCENL6 NB7PSE128C 2*512/120/8L/5R/CB_bg_0.3C_AN	ATTL52	NB7 P-SE	N120GB5.4K	NSM8X
AS9303WSMi	AS9303WSMi MCENO5 NB7PSE128C 2*512/120/8L/5R/CB_bg_0.3C_AN	ATTL52	NB7 P-SE	N120GB5.4K	NSM8X
AS9303WSMi	AS9303WSMi MCECS5 NB7PSE128C 2*512/120/8L/5R/CB_bg_0.3C_AN	ATTL52	NB7 P-SE	N120GB5.4K	NSM8X
AS9303WSMi	AS9303WSMi MCEUK5 NB7PSE128C 2*512/120/8L/5R/CB_bg_0.3C_AN	ATTL52	NB7 P-SE	N120GB5.4K	NSM8X
AS9303WSMi	AS9303WSMi MCERU9 NB7PSE128C 2*512/120/8L/5R/CB_bg_0.3C_AN	ATTL52	NB7 P-SE	N120GB5.4K	NSM8X
AS9303WSMi	AS9303WSMi MCESV5 NB7PSE128C 2*512/120/8L/5R/CB_bg_0.3C_AN	ATTL52	NB7 P-SE	N120GB5.4K	NSM8X
AS9303WSMi	AS9303WSMi MCETR5 NB7PSE128C 2*512/120/8L/5R/CB_bg_0.3C_AN	ATTL52	NB7 P-SE	N120GB5.4K	NSM8X
AS9303WSMi	AS9303WSMi MCEW8 NB7PSE128C 2*512/120/8L/5R/CB_bg_0.3C_AN	ATTL52	NB7 P-SE	N120GB5.4K	NSM8X
AS9303WSMi	AS9303WSMi MCEPL7 NB7PSE128C 2*512/120/8L/5R/CB_bg_0.3C_AN	ATTL52	NB7 P-SE	N120GB5.4K	NSM8X
AS9303WSMi	AS9303WSMi MCES11 NB7PSE128C 2*512/120/8L/5R/CB_bg_0.3C_AN	ATTL52	NB7 P-SE	N120GB5.4K	NSM8X
AS9303WSMi	AS9303WSMi MCEPT6 NB7PSE128C 2*512/120/8L/5R/CB_bg_0.3C_AN	ATTL52	NB7 P-SE	N120GB5.4K	NSM8X
AS9302WSMi	AS9302WSMi MCECF NB7PSE128C 2*1G/120/8L/5R/CB_bg_0.3C_AN	ATTL50	NB7 P-SE	N120GB5.4K	NSM8X
AS9302WSMi	AS9302WSMi MCEUS NB7PSE128C 2*1G/120/8L/5R/CB_bg_0.3C_AN	ATTL50	NB7 P-SE	N120GB5.4K	NSM8X
AS9302WSMi	AS9302WSMi MCEAR1 NB7PSE128C 2*512/100/8L/5R/CB_bg_0.3C_AN	ATTL50	NB7 P-SE	N100GB5.4K	NSM8X
AS9302WSMi	AS9302WSMi MCEAR2 NB7PSE128C 2*512/100/8L/5R/CB_bg_0.3C_AN	ATTL50	NB7 P-SE	N100GB5.4K	NSM8X
AS9302WSMi	AS9302WSMi MCEWUK11W NB7PSE128C 2*512/100/8L/5R/CB_bg_0.3C_AN	ATTL50	NB7 P-SE	N100GB5.4K	NSM8X
AS9302WSMi	AS9302WSMi MCEWFR11W NB7PSE128C 2*512/100/8L/5R/CB_bg_0.3C_AN	ATTL50	NB7 P-SE	N100GB5.4K	NSM8X
AS9302WSMi	AS9302WSMi MCEWDE11W NB7PSE128C 2*512/100/8L/5R/CB_bg_0.3C_AN	ATTL50	NB7 P-SE	N100GB5.4K	NSM8X
AS9302WSMi	AS9302WSMi MCEWIT11W NB7PSE128C 2*512/100/8L/5R/CB_bg_0.3C_AN	ATTL50	NB7 P-SE	N100GB5.4K	NSM8X
AS9303WSMi	AS9303WSMi MCEWFR11W NB7PSE128C 2*512/120/8L/5R/CB_bg_0.3C_AN	ATTL52	NB7 P-SE	N120GB5.4K	NSM8X
AS9303WSMi	AS9303WSMi MCEAR1 NB7PSE128C 2*512/120/8L/5R/CB_bg_0.3C_AN	ATTL52	NB7 P-SE	N120GB5.4K	NSM8X
AS9303WSMi	AS9303WSMi MCEWDE11W NB7PSE128C 2*512/120/8L/5R/CB_bg_0.3C_AN	ATTL52	NB7 P-SE	N120GB5.4K	NSM8X
AS9303WSMi	AS9303WSMi MCEWUK11W NB7PSE128C 2*512/120/8L/5R/CB_bg_0.3C_AN	ATTL52	NB7 P-SE	N120GB5.4K	NSM8X

Model	Description	CPU	VGA Chip	HDD 1 (GB)	ODD
AS9303WSMi	AS9303WSMi MCEWIT11W NB7PSE128C 2*512/120/8L/5R/ CB_bg_0.3C_AN	ATTL52	NB7 P-SE	N120GB5. 4K	NSM8X

Model	Description	CPU	VGA Chip	HDD 1 (GB)	ODD
AS9302WSMi	AS9302WSMi XPHSA1 UMAC 1*512/100/ 6L/5R/CB_bg_0.3C_AN	ATTL50	UMA	N100GB5.4 K	NSM8X
AS9302WSMi	AS9302WSMi XPHDK1 UMAC 1*512/100/ 6L/5R/CB_bg_0.3C_AN	ATTL50	UMA	N100GB5.4 K	NSM8X
AS9302WSMi	AS9302WSMi XPHBE1 UMAC 1*512/100/ 6L/5R/CB_bg_0.3C_AN	ATTL50	UMA	N100GB5.4 K	NSM8X
AS9302WSMi	AS9302WSMi XPHNL1 UMAC 1*512/100/ 6L/5R/CB_bg_0.3C_AN	ATTL50	UMA	N100GB5.4 K	NSM8X
AS9302WSMi	AS9302WSMi XPHNO1 UMAC 1*512/100/ 6L/5R/CB_bg_0.3C_AN	ATTL50	UMA	N100GB5.4 K	NSM8X
AS9302WSMi	AS9302WSMi XPHRU2 UMAC 1*512/100/ 6L/5R/CB_bg_0.3C_AN	ATTL50	UMA	N100GB5.4 K	NSM8X
AS9302WSMi	AS9302WSMi XPHSV1 UMAC 1*512/100/ 6L/5R/CB_bg_0.3C_AN	ATTL50	UMA	N100GB5.4 K	NSM8X
AS9302WSMi	AS9302WSMi XPHCS2 UMAC 1*512/100/ 6L/5R/CB_bg_0.3C_AN	ATTL50	UMA	N100GB5.4 K	NSM8X
AS9302WSMi	AS9302WSMi XPHWFRB1W UMAC 1*512/100/6L/5R/CB_bg_0.3C_AN	ATTL50	UMA	N100GB5.4 K	NSM8X
AS9302WSMi	AS9302WSMi XPHDE7 UMAC 1*512/100/ 6L/5R/CB_bg_0.3C_AN	ATTL50	UMA	N100GB5.4 K	NSM8X
AS9302WSMi	AS9302WSMi XPHHU6 UMAC 1*512/100/ 6L/5R/CB_bg_0.3C_AN	ATTL50	UMA	N100GB5.4 K	NSM8X
AS9302WSMi	AS9302WSMi XPHPL6 UMAC 1*512/100/ 6L/5R/CB_bg_0.3C_AN	ATTL50	UMA	N100GB5.4 K	NSM8X
AS9302WSMi	AS9302WSMi XPHSLO2 UMAC 1*512/ 100/6L/5R/CB_bg_0.3C_AN	ATTL50	UMA	N100GB5.4 K	NSM8X
AS9302WSMi	AS9302WSMi XPHESA UMAC 1*512/100/ 6L/5R/CB_bg_0.3C_AN	ATTL50	UMA	N100GB5.4 K	NSM8X
AS9302WSMi	AS9302WSMi XPHPT1 UMAC 1*512/100/ 6L/5R/CB_bg_0.3C_AN	ATTL50	UMA	N100GB5.4 K	NSM8X
AS9302WSMi	AS9302WSMi XPHL1 UMAC 1*512/100/ 6L/5R/CB_bg_0.3C_AN	ATTL50	UMA	N100GB5.4 K	NSM8X
AS9302WSMi	AS9302WSMi XPHIS1 UMAC 1*512/100/ 6L/5R/CB_bg_0.3C_AN	ATTL50	UMA	N100GB5.4 K	NSM8X
AS9302WSMi	AS9302WSMi XPHTR1 UMAC 1*512/100/ 6L/5R/CB_bg_0.3C_AN	ATTL50	UMA	N100GB5.4 K	NSM8X
AS9302WSMi	AS9302WSMi XPHWIT21W UMAC 1*512/ 100/6L/5R/CB_bg_0.3C_AN	ATTL50	UMA	N100GB5.4 K	NSM8X
AS9302WSMi	AS9302WSMi XPHAR1 UMAC 1*512/100/ 6L/5R/CB_bg_0.3C_AN	ATTL50	UMA	N100GB5.4 K	NSM8X
AS9302WSMi	AS9302WSMi XPHSW5 UMAC 1*512/ 100/6L/5R/CB_bg_0.3C_AN	ATTL50	UMA	N100GB5.4 K	NSM8X

Model	Description	CPU	VGA Chip	HDD 1 (GB)	ODD
AS9302WSMi	AS9302WSMi XPHWUK21W UMAC 1*512/100/6L/5R/CB_bg_0.3C_AN	ATTL50	UMA	N100GB5.4 K	NSM8X
AS9302WSMi	AS9302WSMi XPHSA1 UMAC 2*512/120/6L/5R/CB_bg_0.3C_AN	ATTL50	UMA	N120GB5.4 K	NSM8X
AS9302WSMi	AS9302WSMi XPHDK1 UMAC 2*512/120/6L/5R/CB_bg_0.3C_AN	ATTL50	UMA	N120GB5.4 K	NSM8X
AS9302WSMi	AS9302WSMi XPHBE1 UMAC 2*512/120/6L/5R/CB_bg_0.3C_AN	ATTL50	UMA	N120GB5.4 K	NSM8X
AS9302WSMi	AS9302WSMi XPHNL1 UMAC 2*512/120/6L/5R/CB_bg_0.3C_AN	ATTL50	UMA	N120GB5.4 K	NSM8X
AS9302WSMi	AS9302WSMi XPHNO1 UMAC 2*512/120/6L/5R/CB_bg_0.3C_AN	ATTL50	UMA	N120GB5.4 K	NSM8X
AS9302WSMi	AS9302WSMi XPHRU2 UMAC 2*512/120/6L/5R/CB_bg_0.3C_AN	ATTL50	UMA	N120GB5.4 K	NSM8X
AS9302WSMi	AS9302WSMi XPHSV1 UMAC 2*512/120/6L/5R/CB_bg_0.3C_AN	ATTL50	UMA	N120GB5.4 K	NSM8X
AS9302WSMi	AS9302WSMi XPHWFRB1W UMAC 2*512/120/6L/5R/CB_bg_0.3C_AN	ATTL50	UMA	N120GB5.4 K	NSM8X
AS9302WSMi	AS9302WSMi XPHDE7 UMAC 2*512/120/6L/5R/CB_bg_0.3C_AN	ATTL50	UMA	N120GB5.4 K	NSM8X
AS9302WSMi	AS9302WSMi XPHCS2 UMAC 2*512/120/6L/5R/CB_bg_0.3C_AN	ATTL50	UMA	N120GB5.4 K	NSM8X
AS9302WSMi	AS9302WSMi XPHHU6 UMAC 2*512/120/6L/5R/CB_bg_0.3C_AN	ATTL50	UMA	N120GB5.4 K	NSM8X
AS9302WSMi	AS9302WSMi XPHPL6 UMAC 2*512/120/6L/5R/CB_bg_0.3C_AN	ATTL50	UMA	N120GB5.4 K	NSM8X
AS9302WSMi	AS9302WSMi XPHSLO2 UMAC 2*512/120/6L/5R/CB_bg_0.3C_AN	ATTL50	UMA	N120GB5.4 K	NSM8X
AS9302WSMi	AS9302WSMi XPHESA UMAC 2*512/120/6L/5R/CB_bg_0.3C_AN	ATTL50	UMA	N120GB5.4 K	NSM8X
AS9302WSMi	AS9302WSMi XPHPT1 UMAC 2*512/120/6L/5R/CB_bg_0.3C_AN	ATTL50	UMA	N120GB5.4 K	NSM8X
AS9302WSMi	AS9302WSMi XPHL1 UMAC 2*512/120/6L/5R/CB_bg_0.3C_AN	ATTL50	UMA	N120GB5.4 K	NSM8X
AS9302WSMi	AS9302WSMi XPHIS1 UMAC 2*512/120/6L/5R/CB_bg_0.3C_AN	ATTL50	UMA	N120GB5.4 K	NSM8X
AS9302WSMi	AS9302WSMi XPHTR1 UMAC 2*512/120/6L/5R/CB_bg_0.3C_AN	ATTL50	UMA	N120GB5.4 K	NSM8X
AS9302WSMi	AS9302WSMi XPHWIT21W UMAC 2*512/120/6L/5R/CB_bg_0.3C_AN	ATTL50	UMA	N120GB5.4 K	NSM8X
AS9302WSMi	AS9302WSMi XPHAR1 UMAC 2*512/120/6L/5R/CB_bg_0.3C_AN	ATTL50	UMA	N120GB5.4 K	NSM8X
AS9302WSMi	AS9302WSMi XPHSW5 UMAC 2*512/120/6L/5R/CB_bg_0.3C_AN	ATTL50	UMA	N120GB5.4 K	NSM8X
AS9302WSMi	AS9302WSMi XPHWUK21W UMAC 2*512/120/6L/5R/CB_bg_0.3C_AN	ATTL50	UMA	N120GB5.4 K	NSM8X
AS9302WSMi	AS9302WSMi MCECF UMAC 1*512/100/6L/5R/CB_bg_0.3C_AN	ATTL50	UMA	N100GB5.4 K	NSM8X
AS9302WSMi	AS9302WSMi MCEUS UMAC 1*512/100/6L/5R/CB_bg_0.3C_AN	ATTL50	UMA	N100GB5.4 K	NSM8X
AS9302WSMi	AS9302WSMi XPHEN1 UMAC 1*512/100/6L/5R/CB_bg_0.3C_AN	ATTL50	UMA	N100GB5.4 K	NSM8X



Model	Description	CPU	VGA Chip	HDD 1 (GB)	ODD
AS9302WSMi	AS9302WSMi XPHFR1 UMAC 1*512/100/6L/5R/CB_bg_0.3C_AN	ATTL50	UMA	N100GB5.4 K	NSM8X
AS9302WSMi	AS9302WSMi XPHES1 UMAC 1*512/100/6L/5R/CB_bg_0.3C_AN	ATTL50	UMA	N100GB5.4 K	NSM8X
AS9302WSMi	AS9302WSMi XPHXC1 UMAC 1*512/100/6L/5R/CB_bg_0.3C_AN	ATTL50	UMA	N100GB5.4 K	NSM8X
AS9302WSMi	AS9302WSMi MCEAU1 UMAC 1*512/100/6L/5R/CB_bg_0.3C_AN	ATTL50	UMA	N100GB5.4 K	NSM8X
AS9302WSMi	AS9302WSMi MCESG1 UMAC 1*512/100/6L/5R/CB_bg_0.3C_AN	ATTL50	UMA	N100GB5.4 K	NSM8X
AS9302WSMi	AS9302WSMi XPHFRA UMAC 2*512/120/6L/5R/CB_bg_0.3C_AN	ATTL50	UMA	N120GB5.4 K	NSM8X
AS9301AWSMi	AS9301AWSMi MCEBE6 UMAC 2*512/100/6L/5R/CB_bg_0.3C_AN	ATMK36	UMA	N100GB5.4 K	NSM8X
AS9301AWSMi	AS9301AWSMi MCENL6 UMAC 2*512/100/6L/5R/CB_bg_0.3C_AN	ATMK36	UMA	N100GB5.4 K	NSM8X
AS9301AWSMi	AS9301AWSMi MCENO5 UMAC 2*512/100/6L/5R/CB_bg_0.3C_AN	ATMK36	UMA	N100GB5.4 K	NSM8X
AS9301AWSMi	AS9301AWSMi MCEESJ UMAC 2*512/100/6L/5R/CB_bg_0.3C_AN	ATMK36	UMA	N100GB5.4 K	NSM8X
AS9301AWSMi	AS9301AWSMi MCEIT7 UMAC 2*512/100/6L/5R/CB_bg_0.3C_AN	ATMK36	UMA	N100GB5.4 K	NSM8X
AS9301AWSMi	AS9301AWSMi MCECS5 UMAC 2*512/100/6L/5R/CB_bg_0.3C_AN	ATMK36	UMA	N100GB5.4 K	NSM8X
AS9301AWSMi	AS9301AWSMi MCEDK6 UMAC 2*512/100/6L/5R/CB_bg_0.3C_AN	ATMK36	UMA	N100GB5.4 K	NSM8X
AS9301AWSMi	AS9301AWSMi MCEFRF UMAC 2*512/100/6L/5R/CB_bg_0.3C_AN	ATMK36	UMA	N100GB5.4 K	NSM8X
AS9301AWSMi	AS9301AWSMi MCEDEA UMAC 2*512/100/6L/5R/CB_bg_0.3C_AN	ATMK36	UMA	N100GB5.4 K	NSM8X
AS9301AWSMi	AS9301AWSMi MCEDEB UMAC 2*512/100/6L/5R/CB_bg_0.3C_AN	ATMK36	UMA	N100GB5.4 K	NSM8X
AS9301AWSMi	AS9301AWSMi MCETR5 UMAC 2*512/100/6L/5R/CB_bg_0.3C_AN	ATMK36	UMA	N100GB5.4 K	NSM8X
AS9301AWSMi	AS9301AWSMi MCESW8 UMAC 2*512/100/6L/5R/CB_bg_0.3C_AN	ATMK36	UMA	N100GB5.4 K	NSM8X
AS9301AWSMi	AS9301AWSMi MCEUK5 UMAC 2*512/100/6L/5R/CB_bg_0.3C_AN	ATMK36	UMA	N100GB5.4 K	NSM8X
AS9301AWSMi	AS9301AWSMi MCERU9 UMAC 2*512/100/6L/5R/CB_bg_0.3C_AN	ATMK36	UMA	N100GB5.4 K	NSM8X
AS9301AWSMi	AS9301AWSMi MCESV5 UMAC 2*512/100/6L/5R/CB_bg_0.3C_AN	ATMK36	UMA	N100GB5.4 K	NSM8X
AS9301AWSMi	AS9301AWSMi MCEPL7 UMAC 2*512/100/6L/5R/CB_bg_0.3C_AN	ATMK36	UMA	N100GB5.4 K	NSM8X
AS9301AWSMi	AS9301AWSMi MCES11 UMAC 2*512/100/6L/5R/CB_bg_0.3C_AN	ATMK36	UMA	N100GB5.4 K	NSM8X
AS9301AWSMi	AS9301AWSMi MCEPT6 UMAC 2*512/100/6L/5R/CB_bg_0.3C_AN	ATMK36	UMA	N100GB5.4 K	NSM8X
AS9301AWSMi	AS9301AWSMi MCEWUK1 UMAC 2*512/100/6L/5R/CB_bg_0.3C_AN	ATMK36	UMA	N100GB5.4 K	NSM8X
AS9302WSMi	AS9302WSMi MCECF UMAC 2*512/120/6L/5R/CB_bg_0.3C_AN	ATTL50	UMA	N120GB5.4 K	NSM8X

Model	Description	CPU	VGA Chip	HDD 1 (GB)	ODD
AS9302WSMi	AS9302WSMi MCEUS UMAC 2*512/120/6L/5R/CB_bg_0.3C_AN	ATTL50	UMA	N120GB5.4K	NSM8X
AS9302WSMi	AS9302WSMi MCEES1 UMAC 2*512/120/6L/5R/CB_bg_0.3C_AN	ATTL50	UMA	N120GB5.4K	NSM8X
AS9302WSMi	AS9302WSMi MCECF UMAC 2*512/160/6L/5R/CB_bg_0.3C_AN	ATTL50	UMA	N160GB5.4K	NSM8X
AS9302WSMi	AS9302WSMi MCEES1 UMAC 2*512/160/6L/5R/CB_bg_0.3C_AN	ATTL50	UMA	N160GB5.4K	NSM8X
AS9302WSMi	AS9302WSMi MCEUS UMAC 2*512/160/6L/5R/CB_bg_0.3C_AN	ATTL50	UMA	N160GB5.4K	NSM8X
AS9301AWSMi	AS9301AWSMi MCEAR1 UMAC 2*512/100/6L/5R/CB_bg_0.3C_AN	ATMK36	UMA	N100GB5.4K	NSM8X
AS9301AWSMi	AS9301AWSMi MCEAR2 UMAC 2*512/100/6L/5R/CB_bg_0.3C_AN	ATMK36	UMA	N100GB5.4K	NSM8X
AS9301AWSMi	AS9301AWSMi MCEWUK11W UMAC 2*512/100/6L/5R/CB_bg_0.3C_AN	ATMK36	UMA	N100GB5.4K	NSM8X
AS9301AWSMi	AS9301AWSMi MCEWDE11W UMAC 2*512/100/6L/5R/CB_bg_0.3C_AN	ATMK36	UMA	N100GB5.4K	NSM8X
AS9301AWSMi	AS9301AWSMi MCEWFR11W UMAC 2*512/100/6L/5R/CB_bg_0.3C_AN	ATMK36	UMA	N100GB5.4K	NSM8X
AS9301AWSMi	AS9301AWSMi MCEWIT11W UMAC 2*512/100/6L/5R/CB_bg_0.3C_AN	ATMK36	UMA	N100GB5.4K	NSM8X
AS9302WSMi	AS9302WSMi MCEAR1 UMAC 2*512/120/6L/5R/CB_bg_0.3C_AN	ATTL50	UMA	N120GB5.4K	NSM8X
AS9302WSMi	AS9302WSMi MCEAR2 UMAC 2*512/120/6L/5R/CB_bg_0.3C_AN	ATTL50	UMA	N120GB5.4K	NSM8X
AS9302WSMi	AS9302WSMi MCEBE6 UMAC 2*512/120/6L/5R/CB_bg_0.3C_AN	ATTL50	UMA	N120GB5.4K	NSM8X
AS9302WSMi	AS9302WSMi MCENL6 UMAC 2*512/120/6L/5R/CB_bg_0.3C_AN	ATTL50	UMA	N120GB5.4K	NSM8X
AS9302WSMi	AS9302WSMi MCEESJ UMAC 2*512/120/6L/5R/CB_bg_0.3C_AN	ATTL50	UMA	N120GB5.4K	NSM8X
AS9302WSMi	AS9302WSMi MCEIT7 UMAC 2*512/120/6L/5R/CB_bg_0.3C_AN	ATTL50	UMA	N120GB5.4K	NSM8X
AS9302WSMi	AS9302WSMi MCEDEA UMAC 2*512/120/6L/5R/CB_bg_0.3C_AN	ATTL50	UMA	N120GB5.4K	NSM8X
AS9302WSMi	AS9302WSMi MCEDEB UMAC 2*512/120/6L/5R/CB_bg_0.3C_AN	ATTL50	UMA	N120GB5.4K	NSM8X
AS9302WSMi	AS9302WSMi MCECS5 UMAC 2*512/120/6L/5R/CB_bg_0.3C_AN	ATTL50	UMA	N120GB5.4K	NSM8X
AS9302WSMi	AS9302WSMi MCEDK6 UMAC 2*512/120/6L/5R/CB_bg_0.3C_AN	ATTL50	UMA	N120GB5.4K	NSM8X
AS9302WSMi	AS9302WSMi MCEFRF UMAC 2*512/120/6L/5R/CB_bg_0.3C_AN	ATTL50	UMA	N120GB5.4K	NSM8X
AS9302WSMi	AS9302WSMi MCEPL7 UMAC 2*512/120/6L/5R/CB_bg_0.3C_AN	ATTL50	UMA	N120GB5.4K	NSM8X
AS9302WSMi	AS9302WSMi MCES11 UMAC 2*512/120/6L/5R/CB_bg_0.3C_AN	ATTL50	UMA	N120GB5.4K	NSM8X
AS9302WSMi	AS9302WSMi MCEPT6 UMAC 2*512/120/6L/5R/CB_bg_0.3C_AN	ATTL50	UMA	N120GB5.4K	NSM8X
AS9302WSMi	AS9302WSMi MCENO5 UMAC 2*512/120/6L/5R/CB_bg_0.3C_AN	ATTL50	UMA	N120GB5.4K	NSM8X



Model	Description	CPU	VGA Chip	HDD 1 (GB)	ODD
AS9302WSMi	AS9302WSMi MCERU9 UMAC 2*512/120/6L/5R/CB_bg_0.3C_AN	ATTL50	UMA	N120GB5.4 K	NSM8X
AS9302WSMi	AS9302WSMi MCETR5 UMAC 2*512/120/6L/5R/CB_bg_0.3C_AN	ATTL50	UMA	N120GB5.4 K	NSM8X
AS9302WSMi	AS9302WSMi MCESW8 UMAC 2*512/120/6L/5R/CB_bg_0.3C_AN	ATTL50	UMA	N120GB5.4 K	NSM8X
AS9302WSMi	AS9302WSMi MCESV5 UMAC 2*512/120/6L/5R/CB_bg_0.3C_AN	ATTL50	UMA	N120GB5.4 K	NSM8X
AS9302WSMi	AS9302WSMi MCEUK5 UMAC 2*512/120/6L/5R/CB_bg_0.3C_AN	ATTL50	UMA	N120GB5.4 K	NSM8X
AS9302WSMi	AS9302WSMi MCEWUK11W UMAC 2*512/120/6L/5R/CB_bg_0.3C_AN	ATTL50	UMA	N120GB5.4 K	NSM8X
AS9302WSMi	AS9302WSMi MCEWIT11W UMAC 2*512/120/6L/5R/CB_bg_0.3C_AN	ATTL50	UMA	N120GB5.4 K	NSM8X
AS9302WSMi	AS9302WSMi MCEWDE11W UMAC 2*512/120/6L/5R/CB_bg_0.3C_AN	ATTL50	UMA	N120GB5.4 K	NSM8X
AS9302WSMi	AS9302WSMi MCEWFR11W UMAC 2*512/120/6L/5R/CB_bg_0.3C_AN	ATTL50	UMA	N120GB5.4 K	NSM8X

## ***Test Compatible Components***

---

This computer's compatibility is tested and verified by Acer's internal testing department. All of its system functions are tested under Windows® XP Home, Windows® XP Pro environment.

Refer to the following lists for components, adapter cards, and peripherals which have passed these tests. Regarding configuration, combination and test procedures, please refer to the Aspire 9300/7000&TM7510 series Compatibility Test Report released by the Acer Mobile System Testing Department.

# Microsoft® Windows® XP Pro Environment Test

Vendor	Device Description	Result
<b>Basic PC Card List - Lan Card</b>		
IBM	EtherJet CardBus Adapter 10/100	P
Xircom	CardBus Ethernet 10/100 32Bit	P
USR	Megahertz 56K PC Card Modem	P
Xircom	RealPort CardBus Ethernet 10/100 + Modem 56	P
Intel	Flash 1MB Memory Card*1	P
IBM	Microdrive 1G	P
Iomega	Click! 40MB	P
Apacer	Compact Flash Card 256MB	P
Apacer	SD Flash Card 128MB	P
Apacer	128MB Memory Stick	P
<b>Advance PC Card List - USB2.0 Card(*1)</b>		
Adaptec	USB2 CONNECT	P
IOGEAR	Cardbus Card USB 2.0	P
<b>Advance PC Card List - 1394 Card(*1)</b>		
Buffalo	1394 Interface Cardbus(4 pin)	P
I-O Data	1394 Interface Cardbus(6 pin)	P
<b>Advance PC Card List - Wireless Lan Card(*1)</b>		
Cisco	Aironet 350 series Wireless Lan Card 802.11b	P
Cisco	Wireless Lan Card 802.11a	P
Intel	Pro/Wireless Lan PC Card(*2)	P
NETGEAR	Wireless Lab Card 802.11a	P
<b>Advance PC Card List - ISDN Card</b>		
US Robotics	Megahertz 128K ISDN Card	P
<b>Advance PC Card List - Token Ring Card</b>		
IBM	Token Ring 16/4 Adapter II	P
<b>Advance PC Card List - 3G/GPRS Card</b>		
Sony Ericsson	GC89 GPRS Card	Future_release
Vodafone	3G/GPRS Card	P
<b>I/O Peripheral List - External CRT</b>		
Acer	"211c 21""	P
ViewSonic	G220F	P
ViewSonic	"PF790 19""	P
<b>I/O Peripheral List - External LCD</b>		

Vendor	Device Description	Result
Acer	"FP751 17"" TFT LCD"	P
Acer	"15"" LCD Monitor (DVI) Model:AL1521(*1)"	P
Acer	"17"" LCD Monitor (DVI) Model:AL1721(*1)"	P
ViewSonic	"20" LCD VD201b(DVI-I) ,(DVI-D),(D-sub) (*1)"	P
<b>I/O Peripheral List - Projector</b>		
NEC	MultiSync MT-1040	P
<b>I/O Peripheral List - Scanner</b>		
Acer	AcerScan Prisa 620P	P
<b>I/O Peripheral List - IR Printer</b>		
HP	LaserJet 2200 use IR	P
<b>I/O Peripheral List - IR Mobile Phone</b>		
Sony Ericsson	T610	P
<b>I/O Peripheral List - USB Keyboard / Mouse</b>		
Microsoft	Natural Keyboard Pro	P
Dell	USB Keyboard	P
Logicool	USB Mouse	P
Logitech	USB Wheel Mouse	P
Logitech	First Wheel Mouse	P
Dell	Dell by logitech	P
<b>I/O Peripheral List - USB Printer / Scanner</b>		
Canon	CanonScan D1250 (usb 2.0)	P
HP	Deskjet 995C (usb interface)	P
<b>I/O Peripheral List - USB Speaker / Joystick</b>		
Aiwa	Multimedia Digital Speaker	P
Logitech	WingMan RumblePad	P
<b>I/O Peripheral List - USB Camera</b>		
Intel	Easy PC Camera	P
Orange	Micro Usb 2.0 Web Cam	P
<b>I/O Peripheral List - USB Storage Drive</b>		
lomega	USB Zip 250MB	P
Fujitsu	MO-1300 1.3G (usb 2.0)	P
Fujitsu	20G HDD (usb 2.0) (*2)	P
PQI	6 IN 1 Flash Card Reader/Writer(*1)	P
Plextor	DVD+R/RW (Usb2.0)	P
Galileo	Mass Storage 2.5 Travel Kit	P
<b>I/O Peripheral List - USB Flash Drive</b>		

Vendor	Device Description	Result
Apacer	USB Handy Drive 32/128/256/512MB	P
Apacer	USB2.0 Handy Driver 256/512MB	P
Sony	Memery Key 128MB	P
<b>I/O Peripheral List - USB Hub and Others</b>		
A TEN	4 Port Hub (usb 2.0)	P
IOGEAR	4 Port Hub (usb 2.0)	P
Corega	WirelessLAN USB Stick11 (usb 1.1) *1	P
<b>I/O Peripheral List - USB Peripheral</b>		
Logitech	CDRW + DVDROM combo USB interface	P
Fujitsu	20G HDD (usb 2.0)	P
Panasonic	USB Speaker EAB-MPC57USB	P
<b>I/O Peripheral List - 1394 Storage Drive (*1)</b>		
Logitech	Fireware CDRW + DVDROM Combo	P
I-O Data	Fireware HD I.LINK 30GB	P
VST	Fireware HD	P
Maxtor	External Storage 80GB 1394 HDD	P
Smartdick	Firelite Hard Devies for 1394(*2)	P
<b>I/O Peripheral List - 1394 Scanner</b>		
N/A		
<b>I/O Peripheral List - 1394 Camera</b>		
Sony	DV	P
<b>I/O Peripheral List - 1394 Hub</b>		
ADS PYRO	1394 HUB	P
<b>I/O Peripheral List - Fireware Peripheral</b>		
Lacie	Fireware HD 20G 7200RPM EXT-K525	P
<b>I/O Peripheral List - Access Point 802.11b</b>		
Cisco	Aironet 350	P
Cisco	Aironet 1230 (*1)	P
<b>I/O Peripheral List - Access Point 802.11a</b>		
Intel	Pro/Wireless 5000	P
NetGear	54Mbps 802.11a Access Point Model: HE 102	P
<b>I/O Peripheral List - Access Point 802.11g</b>		
D-link	AirPlus Xtreme GTM 2.4GHz Wireless Broad Router	P

Vendor	Device Description	Result
<b>I/O Peripheral List - Misc Peripheral</b>		
X Bridge	Bluetooth Access Point BT300	P
<b>I/O Peripheral List - Bluetooth Device(*1)</b>		
Sony Ericsson	Wireless Headset	P
HP	Deskjet 995C (bluetooth interface)	P
X Bridge	Bluetooth Access Point BT300	P
EPSON	Bluetooth Print Adapter	P
Microsoft	HID Bluetooth Keyboard & Mouse	P
Sony Ericsson	T610	P
<b>I/O Peripheral List - Multimedia Card(*1)</b>		
Sandisk	Multimedia card 32MB	P
Transcend	Multimedia card 64/128MB	P
<b>I/O Peripheral List -RS Multimedia Card(*1)</b>		
Sandisk	RS-Multimedia card 128MB	P
PQI	Multimedia Mobile 256MB	P
<b>I/O Peripheral List - SD Card(*1)</b>		
Apacer	SD card 128/256MB	P
Transcend	SD card 32/256MB	P
HAGIWARA	SD card 256MB(Toshiba chip)	P
Kingmax	1GB 66X SD Card	P
Apacer	Apacer 150X Hi-Speed 2GB SD Flash Card	P
<b>I/O Peripheral List - Memory Stick(*1)</b>		
Sony	Memory stick 64MB	P
Apacer	Memory stick 128MB	P
<b>I/O Peripheral List - XD Card(*1)</b>		
SanDisk	xD-Picture Card 64/128MB	P

## ***Online Support Information***

---

This section describes online technical support services available to help you repair your Acer Systems.

If you are a distributor, dealer, ASP or TPM, please refer your technical queries to your local Acer branch office. Acer Branch Offices and Regional Business Units may access our website. However some information sources will require a user i.d. and password. These can be obtained directly from Acer CSD Taiwan.

Acer's Website offers you convenient and valuable support resources whenever you need them.

In the Technical Information section you can download information on all of Acer's Notebook, Desktop and Server models including:

- Service guides for all models
- User's manuals
- Training materials
- Bios updates
- Software utilities
- Spare parts lists
- TABs (Technical Announcement Bulletin)

For these purposes, we have included an Acrobat File to facilitate the problem-free downloading of our technical material.

Also contained on this website are:

- Detailed information on Acer's International Traveler's Warranty (ITW)
- Returned material authorization procedures
- An overview of all the support services we offer, accompanied by a list of telephone, fax and email contacts for all your technical queries.

We are always looking for ways to optimize and improve our services, so if you have any suggestions or comments, please do not hesitate to communicate these to us.

[www.s-manuals.com](http://www.s-manuals.com)